

User manual

Pressing monitor
EPW 500FP

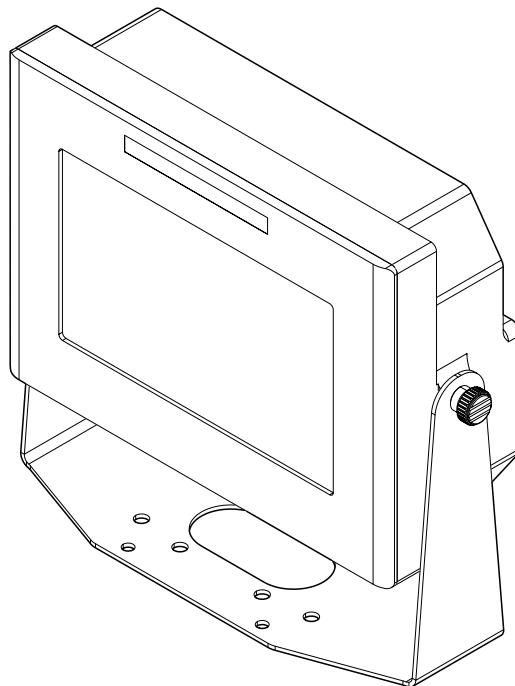

Table of contents

1	Important information	
1.1	Legal note	7
1.2	Exclusion of liability	7
1.3	Validity of the document	8
1.3.1	Content and target group	8
1.3.2	Other applicable documents	8
1.4	Gender note	8
1.5	Displays in the document	9
1.5.1	Display of warnings	9
1.5.2	Display of general notes	10
1.5.3	Highlighting of texts and images	10
1.6	Contact and source of supply	11
2	Safety	
2.1	Basic safety requirements	13
2.2	Organizational measures	14
2.2.1	Safety requirements for the operating company	14
2.2.2	Selection and qualifications of personnel	15
2.3	Fundamental hazard potential	16
2.3.1	Electrical hazards	16
3	About this product	
3.1	Intended use	17
3.1.1	Safe and correct operation	17
3.1.2	Foreseeable misuse	17
3.2	Warranty	18
3.3	Product Identification	18
3.3.1	Position and content of the type plate	18
3.4	Function description	19
3.4.1	Process monitoring system	19
3.4.2	Measuring Mode and Configuration	19

4	Technical data	
4.1	Dimensions	21
4.2	Weight	21
4.3	CPU module	22
4.4	Interfaces	23
4.4.1	DMS force sensor (X1).....	23
4.4.2	Force sensor standard input (X2).....	24
4.4.3	Analog Out (X3)	25
4.4.4	Distance sensor (X4).....	25
4.4.5	Digital IO (X5).....	27
4.4.6	Supply voltage (X6).....	28
4.4.7	USB interface (X7)	28
4.4.8	Ethernet RJ45 (X8)	29
4.5	PLC interface pulse diagrams	30
4.5.1	Start/Stop	30
4.5.2	Changing the program number	31
4.5.3	Environmental conditions	32
5	Transport and storage	
5.1	Temporary storages	35
5.2	Dispatch for repair	35
6	Installation	
6.1	Holding bracket	37
7	Commissioning	
7.1	Preparing System.....	39
7.2	Starting system	39
8	Operation	
8.1	Monitoring operation	41

9	Software	
9.1	Function of the Software	43
9.2	Software interface	43
9.2.1	Information and status bar	44
9.3	Control elements	44
9.3.1	Function buttons.....	44
9.3.2	Checkboxes	45
9.3.3	Selection lists	45
9.3.4	Input field.....	45
9.3.5	Dialog keyboard	46
9.3.6	Saving Changes Dialog.....	48
9.3.7	Icons.....	49
9.4	Main menus.....	50
9.4.1	Channel cockpit.....	50
9.4.2	Full-screen display	51
9.4.3	Status window	52
9.4.4	Configuration.....	53
9.4.5	Monitoring	80
9.4.6	Counters.....	96
9.4.7	Processes	101
9.4.8	System	106
9.4.9	User.....	113
9.4.10	Data.....	115
10	Troubleshooting	
10.1	Detecting faults	125
10.1.1	Acknowledging Messages.....	125
10.1.2	Error messages.....	126
11	Maintenance	
11.1	Maintenance and repair	127
11.2	Safety during maintenance	128
11.3	Maintenance schedule	128
11.4	Controller Battery Change.....	129
11.5	Panel PC Battery Change	130

Maintenance table**12 Repairs**

12.1	Repair work	135
------	-------------------	-----

13 Disassembly and Disposal

13.1	Safety requirements for disassembly	137
13.2	Disassembly	137
13.3	Disposal	137

14 Appendices

14.1	Declaration of conformity	139
------	---------------------------------	-----

Index

1 Important information

1.1 Legal note

All rights reserved.

Operating instructions, manuals, technical descriptions and software published by TOX® PRESSOTECHNIK GmbH & Co. KG ("TOX® PRESSOTECHNIK") are copyright and must not be reproduced, distributed and/or otherwise processed or edited (e.g. by copying, microfilming, translation, transmission in any electronic medium or machine-readable form). Any use - including of extracts - contrary to this condition is prohibited without approval in writing by TOX® PRESSOTECHNIK and may be subject to criminal and civil legal sanctions.

If this manual refers to goods and/or services of third parties, this is for example only or is a recommendation by TOX® PRESSOTECHNIK.

TOX® PRESSOTECHNIK does not accept any liability or warranty/guarantee with reference to the selection, specifications and/or usability of these goods and services. The use and/or representation of trademarked brands that do not belong to TOX® PRESSOTECHNIK are for information only; all rights remain the property of the owner of the trademarked brand.

Operating instructions, manuals, technical descriptions and software are originally compiled in German.

1.2 Exclusion of liability

TOX® PRESSOTECHNIK has checked the contents of this publication to ensure that it conforms to the technical properties and specifications of the products or plant and the description of the software. However, discrepancies may still be present, so we cannot guarantee complete accuracy. The supplier documentation included with the system documentation is an exception.

However, the information in this publication is checked regularly and any required corrections are included in subsequent editions. We are grateful for any corrections and suggestions for improvement. TOX® PRESSOTECHNIK reserves the right to revise the technical specifications of the products or plant and/or the software or documentation without prior notice.

1.3 Validity of the document

1.3.1 Content and target group

This manual contains information and instructions for the safe operation and safe maintenance or servicing of the product.

- All information in this manual is up to date at the time of print. TOX® PRESSOTECHNIK reserves the right to make technical changes that improve the system or increase the standard of safety.
- The information is intended for the operating company as well as operating and service personnel.

1.3.2 Other applicable documents

In addition to the available manual, further documents can be supplied. These documents must also be complied with. Other applicable documents can be, for example:

- additional operating manuals (e.g. of components or of a whole system)
- Supplier documentation
- Instructions, such as software manual, etc.
- Technical data sheets
- Safety data sheets
- Data sheets
- Schematics

1.4 Gender note

In order to enhance readability, references to persons that also relate to all sexes are normally only stated in the usual form in German or in the corresponding translated language in this manual, thus e.g. "operator" (singular) for male or female, or "operators" (plural) for male or female". This should in no way convey any gender discrimination or any violation of the principle of equality, however.

1.5 Displays in the document

1.5.1 Display of warnings

Warning signs indicate potential dangers and describe protective measures. Warning signs precede the instructions for which they are applicable.

Warning signs concerning personal injuries

DANGER

Identifies an immediate danger!

Death or severe injuries will occur if appropriate safety measures are not taken.

→ Measures for remedial action and protection.

WARNING

Identifies a potentially dangerous situation!

Death or serious injury may occur if appropriate safety measures are not taken.

→ Measures for remedial action and protection.

CAUTION

Identifies a potentially dangerous situation!

Injury may occur if appropriate safety measures are not taken.

→ Measures for remedial action and protection.

Warning signs indicating potential damage

NOTE

Identifies a potentially dangerous situation!

Property damage may occur if appropriate safety measures are not taken.

→ Measures for remedial action and protection.

1.5.2 Display of general notes

General notes show information on the product or the described action steps.



Identifies important information and tips for users.

1.5.3 Highlighting of texts and images

The highlighting of texts facilitates orientation in the document.

✓ Identifies prerequisites that must be followed.

1. Action step 1

2. Action step 2: identifies an action step in an operating sequence that must be followed to ensure trouble-free operation.

▷ Identifies the result of an action.

▶ Identifies the result of a complete action.

➔ Identifies a single action step or several action steps that are not in an operating sequence.

The highlighting of operating elements and software objects in texts facilitates distinction and orientation.

- <In square brackets> identifies operating elements, such as buttons, levers and (valves) stopcocks.
- "with quotation marks" identifies software display panels, such as windows, messages, display panels and values.
- **In bold** identifies software buttons, such as buttons, sliders, check-boxes and menus.
- **In bold** identifies input fields for entering text and/or numerical values.

1.6 Contact and source of supply

Only use original spare parts or spare parts approved by TOX® PRESSOTECHNIK.

TOX® PRESSOTECHNIK GmbH & Co. KG

Riedstraße 4

88250 Weingarten / Germany

Tel. +49 (0) 751/5007-333

E-Mail: info@tox-de.com

For additional information and forms see

www.tox-pressotechnik.com

2 Safety

2.1 Basic safety requirements

The product is state of the art. However, operation of the product may involve danger to life and limb for the user or third parties or damage to the plant and other property.

For this reason the following basic safety requirements will apply:

- Read the operating manual and observe all safety requirements and warnings.
- Operate the product only as specified and only if it is in perfect technical condition.
- Remedy any faults in the product or the plant immediately.

2.2 Organizational measures

2.2.1 Safety requirements for the operating company

The operating company is responsible for compliance with the following safety requirements:

- The operating manual must always be kept available at the operation site of the product. Ensure that the information is always complete and in legible form.
- In addition to the operating manual, the generally valid legal and other binding rules and regulations must be provided for the following content and all personnel must be trained accordingly:
 - Work safety
 - Accident prevention
 - Working with hazardous substances
 - First aid
 - Environmental protection
 - Traffic safety
 - Hygiene
- The requirements and contents of the operating manual must be supplemented by existing national regulations (e.g. for prevention of accidents and for environmental protection).
- Instructions for special operating features (e.g. work organization, work processes, appointed personnel) and supervisory and reporting obligations must be added to the operating manual.
- Take action to ensure safe operation and make sure that the product is maintained in a functional condition.
- Only allow authorized persons access to the product.
- Ensure that all personnel work with awareness of safety and potential dangers with reference to the information in the operating manual.
- Provide personal protective equipment.
- Maintain all safety and information on dangers regarding the product complete and in legible condition and replace as required.
- Do not make any changes, carry out attachments or conversions to the product without the written approval of TOX® PRESSOTECHNIK. Action contrary to the above will not be covered by the warranty or the operating approval.
- Make sure that the annual safety inspections are carried out and documented by an expert.

2.2.2 Selection and qualifications of personnel

The following safety requirements are applicable for the selection and qualifications of personnel:

- Only appoint persons to work on the plant who have read and understood the operating manual, and in particular, the safety instructions before starting work. This is particularly important for persons who only work on the plant occasionally, e.g. for maintenance work.
- Only allow persons appointed and authorized for this work access to the plant.
- Only appoint reliable and trained or instructed personnel.
- Only appoint persons to work in the danger zone of the plant who can perceive and understand visual and acoustic indications of danger (e.g. visual and acoustic signals).
- Ensure that assembly and installation work and the initial commissioning are performed exclusively by qualified personnel who have been trained and authorized by TOX® PRESSOTECHNIK.
- Maintenance and repairs must be performed by qualified and trained personnel only.
- Ensure that personnel who are being trained, instructed or are in an apprenticeship can only work on the plant under the supervision of an experienced person.
- Have work on electrical equipment performed only by electricians or trained persons under the direction and supervision of an electrician in accordance with the electrotechnical regulations.

2.3 Fundamental hazard potential

Fundamental hazard potentials exist. The specified examples draw attention to known hazardous situations, but are not complete and do not in any way provide safety and risk awareness action in all situations.

2.3.1 Electrical hazards

Attention should be paid to electrical hazards particularly inside the components in the area of all assemblies of the control system and motors of the installation.

The following basically applies:

- Have work on electrical equipment performed only by electricians or trained persons under the direction and supervision of an electrician in accordance with the electrotechnical regulations.
- Always keep the control box and/or terminal box closed.
- Before commencing work on electrical equipment, switch off the main switch of the system and secure it against being switched back on inadvertently.
- Pay attention to the dissipation of residual energy from the control system of the servomotors.
- Make sure that the components are disconnected from the power supply when carrying out the work.

3 About this product

3.1 Intended use

The pressing monitor ensures constant monitoring of the production process and quality assurance during production.

3.1.1 Safe and correct operation

Intended use includes the following conduct:

- Only operate with the components for which it is specified.
- Follow all instructions in this operating manual.
- Comply with the specified maintenance intervals and perform maintenance work correctly.
- Operate in compliance with the conditions of the technical data.
- Operation with fully assembled and functional safety devices.
- Activities may only be carried out by persons who are qualified or authorized for this purpose.

Any other use or application beyond this does not come under the scope of intended use.

3.1.2 Foreseeable misuse

Use contrary to intended use includes the following foreseeable misuse:

- Operation under conditions that deviate from the technical data.
- Operation without fully assembled and functional connections.
- Operation without fully assembled and functional safety devices.
- Modifications to the product without prior approval by TOX® PRESSOTECHNIK and the approving authority.
- Incorrect parameterization.
- Execution of activities by persons who are not qualified or authorized to do so.

The operating company is exclusively responsible for all personal injury and property damage resulting from non-intended use. Non-intended use will not be covered by the warranty or the operating approval.

3.2 Warranty

Warranty and liability are based on the contractually specified conditions.

Unless specified otherwise:

The TOX® PRESSOTECHNIK GmbH & Co. KG excludes any warranty or liability claims in the event of defects or damage if these are attributable to one or more of the following causes:

- Non-compliance with safety instructions, recommendations, instructions and/or other specifications in the operating manual.
- Non-compliance with the maintenance rules.
- Unauthorized and improper commissioning and operation of the machine or components.
- Improper use of the machine or components.
- Unauthorized constructional modifications to the machine or components or modifications to the software.
- Use of non-genuine spare parts. Batteries, fuses and lamps are not covered by the warranty.

3.3 Product Identification

3.3.1 Position and content of the type plate

The type plate can be found on the back of the device.

Designation on the type plate	Meaning
Type	Product designation
ID No	Material number
SN	Serial number

Tab. 1 Type plate

3.4 Function description

3.4.1 Process monitoring system

The pressing monitor monitors processes, in which precisely defined functional correlations between force and distance have to be verified.

The device reads the force/distance data pairs from two measuring channels <X> and <Y> during the measuring operation. The data are written to memory and can be displayed graphically. The resulting force/distance function is compared with the specified data limits of the set window values or envelope curve. An OK message is issued if the data limits are complied with, otherwise a NOK message is issued.

3.4.2 Measuring Mode and Configuration

The registration of a process with the evaluation can only be started in measuring mode. If settings are changed, no measuring cycle can be started. This is the case, for example, during a program change, zero-point adjustment or when you are in the configuration menu.



The readiness for measuring is shown on the display by means of ready signal RDY.

4 Technical data

4.1 Dimensions

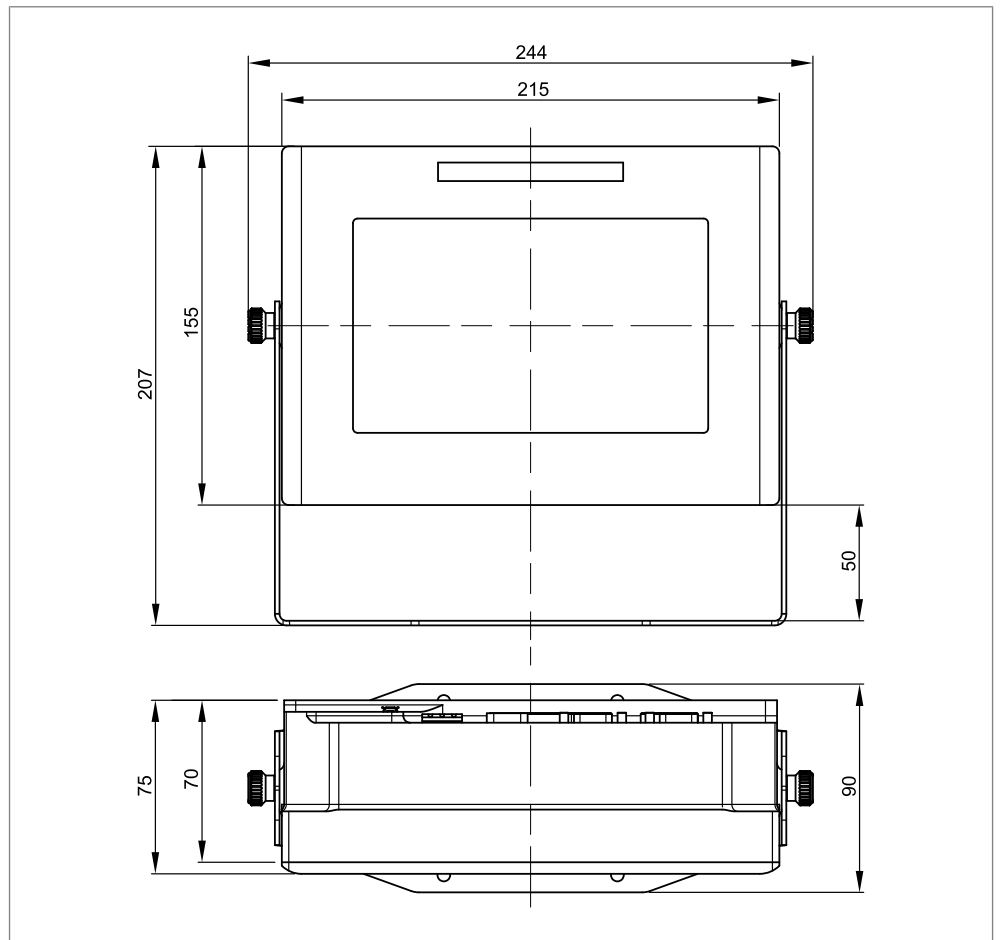

Fig. 1 Dimensions

4.2 Weight

Description	Value
Weight	2.5 kg

4.3 CPU module

Description	Value
Processor	ARM Cortex A8 1 GHz
RAM	eMMC 8 GB (program and data) NAND Flash 256 MB (operating system)
Real-time clock / accuracy	Hardware with buffer battery
Display	LCD 7" 800 x 480 (WVGA) LED, backlit Contrast 400:1 Luminosity 350 cd/m ² Color depth 256 kbit Viewing angle vertical 130°, horizontal 140°
Buffer battery	Controller: Button cell CR2032 Panel-PC: Button cell CR1220

4.4 Interfaces

4.4.1 DMS force sensor (X1)

D-Sub 9-pin (socket)

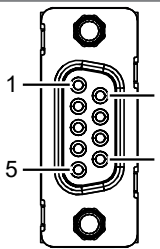
	Pin	Signal	Description
	1	V+ 10V	DMS Supply voltage +10 VDC
	2	n. c.	not connected
	3	S+	DMS Sensor signal pos
	4	n. c.	not connected
	5	n. c.	not connected
	6	n. c.	not connected
	7	S-	DMS Sensor signal neg
	8	n. c.	not connected
	9	V-	Ground 0 VCD
	S		PE shield (housing)

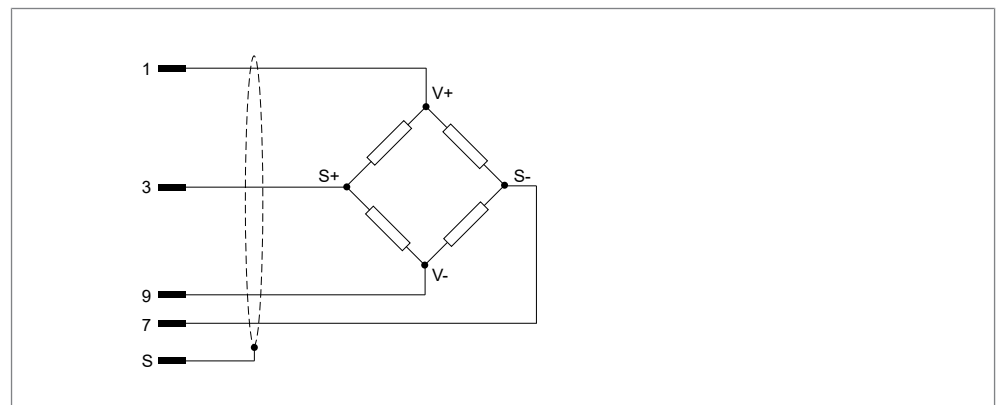
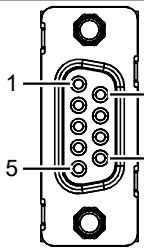

Fig. 2 Connection example: DMS without sensor cable

4.4.2 Force sensor standard input (X2)

D-Sub 9-pin (socket)

	Pin	Signal	Description
	1	n. c.	not connected
	2	V-	Ground 0 VDC
	3	n. c.	not connected
	4	V+ 24V	DMS Supply voltage +24 VDC
	5	Tare 24V	Tare signal
	6	S+	Force signal +10 VDC
	7	n. c.	not connected
	8	S-	Force signal ground GND
	9	n. c.	not connected
	S		PE shield (housing)

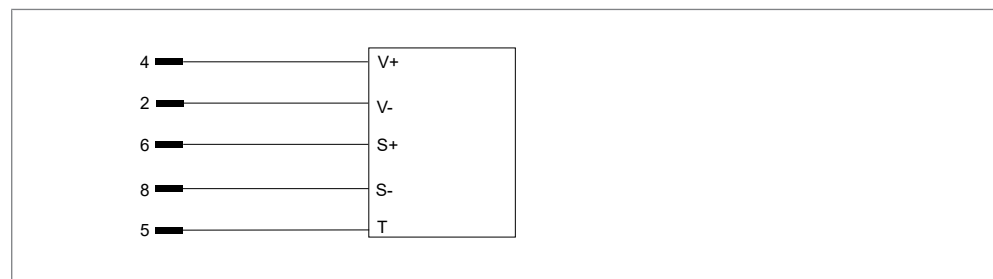

Fig. 3 Connection example: sensor with standard signal 0 to 10 V (ZKN with tare, +24 VDC)

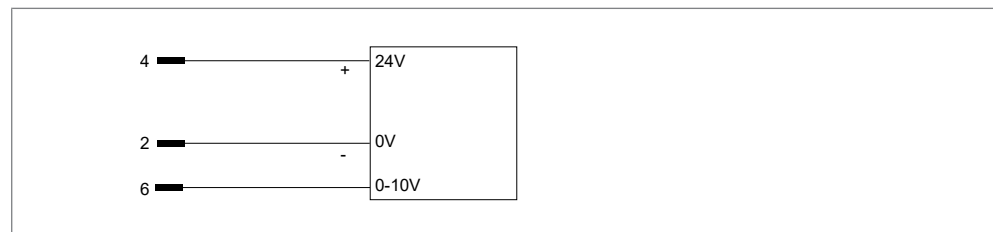
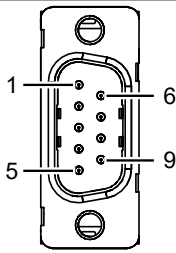

Fig. 4 Connection example: ZDO

4.4.3 Analog Out (X3)

D-Sub 9-pin (connector)

	Pin	Signal	Description
	1	Analog Out 0	Analog Out 0
	2	Analog Out 1	Analog Out 1
	3	Analog Out 2	Analog Out 2
	4	n. c.	not connected
	5	n. c.	not connected
	6	0 V	Ground analog signal
	7	0 V	Ground analog signal
	8	0 V	Ground analog signal
	9	n. c.	not connected
	S		PE shield (housing)

4.4.4 Distance sensor (X4)

D-Sub 15-pin (socket)

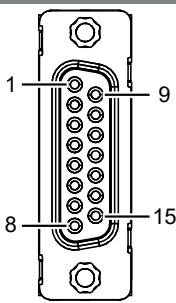
	Pin	Signal	Description
	1	V+ 24V	DMS Supply voltage +24 VDC
	2	Signal 1	Signal 1
	3	Vout 10V	Supply of potentiometric button
	4	Signal 2	Signal 2
	5	V+ 24V	Supply voltage
	6	M1	Monitor output signal 1
	7	n. c.	not connected
	8	La	Internal use
	9	V Ground	Supply voltage ground
	10	0 V	Signal ground
	11	0 V	Signal ground
	12	V Ground	Supply voltage ground
	13	0 V	Signal ground
	14	0 V	Signal ground
	15	Lb	Internal use
	S		PE shield (housing)

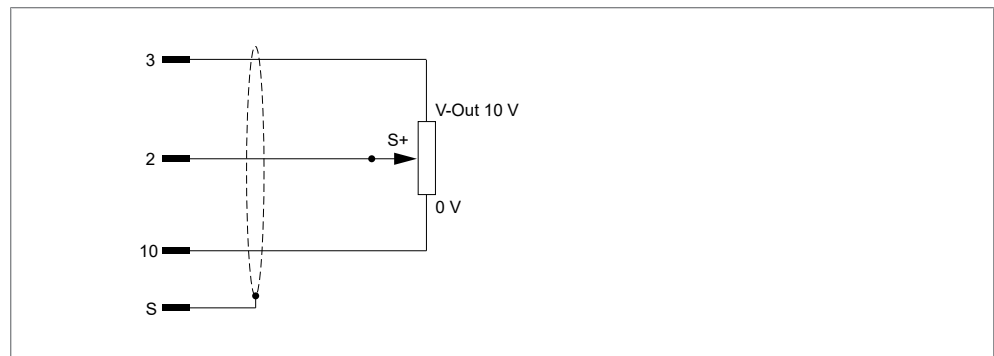

Fig. 5 Connection example: distance transducer potentiometer (ZWW 10 V supply voltage)

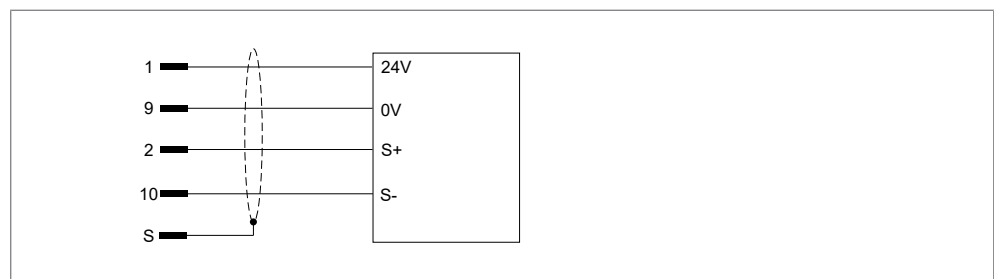
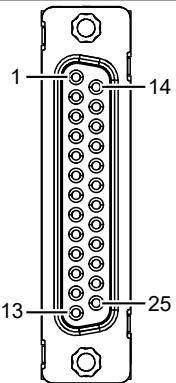

Fig. 6 Connection example: distance transducer (ZKW)

4.4.5 Digital IO (X5)

D-Sub 25-pin (socket)

	Pin	Signal	Description
	1	Q0	OK
	2	Q1	NOK
	3	Q2	Acute NOK
	4	Q3	Switching point 1
	5	Q4	Switching point 2 / NOK buzzer
	6	Q5	Ready for measurement
	7	Q6	Program ACK
	8	Q7	Switching point 3
	9	I 4	Program bit 4
	10	I 5	Program bit 5
	11	0 V	0 V internal
	12	0 V	0 V external
	13	I11	Reserve
	14	I0	Program bit 0
	15	I1	Program bit 1
	16	I2	Program bit 2
	17	I3	Program bit 3
	18	I6	Program strobe
	19	n. c.	not connected
	20	I8	Start measurement
	21	n. c.	not connected
	22	I10	Error reset
	23	24 V	24 V internal
	24	24 V	24 V external
	25	I 12	Reserve
	S		PE shield

Digital inputs

Description	Value
Digital inputs	13 (isolated)
Input voltage	24 V
Input current	At rated voltage (24 V): 3 mA
Input impedance	10 kΩ

Digital outputs

Description	Value
Digital outputs	8 (isolated)
Load voltage	Rated voltage 24 V (permissible range: 18 V to + 30 V)
Vin output current	max. 500 mA
Short-circuit proof	Yes, thermal overload protection

4.4.6 Supply voltage (X6)

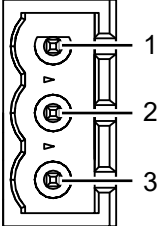
	Pin	Signal	Description
	1	24 V	DMS Supply voltage +24 VDC
	2	GND	Ground 0 VDC
	3	PE	PE shield

Description	Value
Rated voltage	+24 VDC, ±25 % (incl. 10% residual ripple)
Current consumption	≤1 A

4.4.7 USB interface (X7)

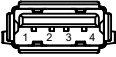
	Pin	Signal	Description
	1	+ 5 V	Supply voltage
	2	Data -	Data -
	3	Data +	Data +
	4	GND	Ground

Description	Value
Number of channels	1 x host (full-speed)
USB 2.0	according to USB device specification USB 2.0 compatible, type A and B Connection to high-powered hub/host
Cable length	max. 5 mm

4.4.8 Ethernet RJ45 (X8)

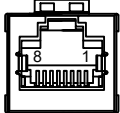
	Pin	Signal	Description
	1	TxD+	Transmit Data +
	2	TxD-	Transmit Data -
	3	RxD+	Receive Data +
	4	n. c.	not connected
	5	n. c.	not connected
	6	RxD-	Receive Data -
	7	n. c.	not connected
	8	n. c.	not connected

Description	Value
1 channel	twisted pair (10/100BASE-T) Transmission in accordance with IEEE/ ANSI 802.3, ISO 8802-3, IEE-E802.3u
Transmission speed	10/100 Mbit/s
Connecting line	shielded at 0.14 mm ² : max. 300 m at 0.25 mm ² : max. 600 m
Length	max. 100 mm
Cable	Shielded, impedance 100 Ω
Connector	RJ45 (modular connector)

4.5 PLC interface pulse diagrams

4.5.1 Start/Stop

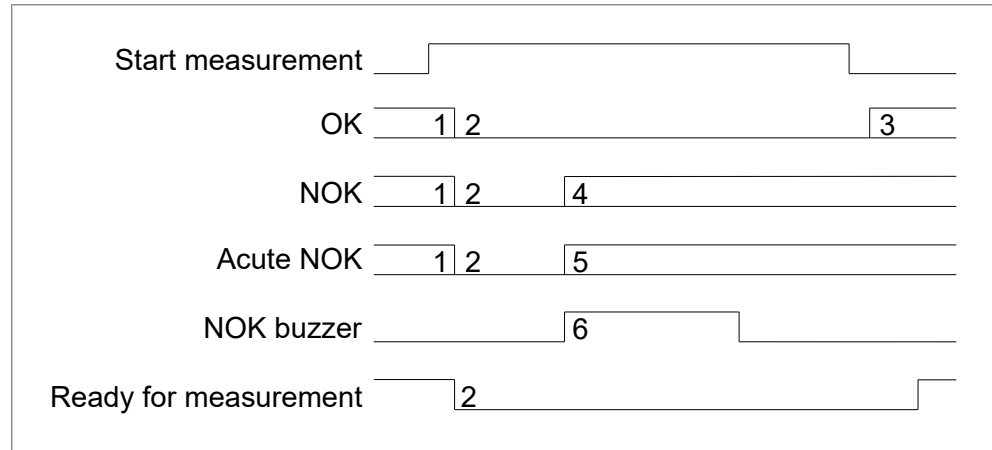

Fig. 7 Signal path diagram

1	Dependent on the previous measured result.
2	When the <Start measuring> signal is active, the conditions of the previous measurement are reset after a maximum of 1 ms.
3	When the measurement has been completed, the OK or NOK signal is set after 1 ms.
4	If the measurement is assessed as NOK during the measurement, the NOK signal is set after a maximum of 1 ms.
5	Depending on the <Acute NOK> option, the signal is set after a maximum of 1 ms after the measurement has been assessed as NOK.
6	Depending on option <NOK beeper>, after the measurement has been assessed as NOK, the signal is set for the duration adjusted in the settings after a maximum of 1 ms.

4.5.2 Changing the program number

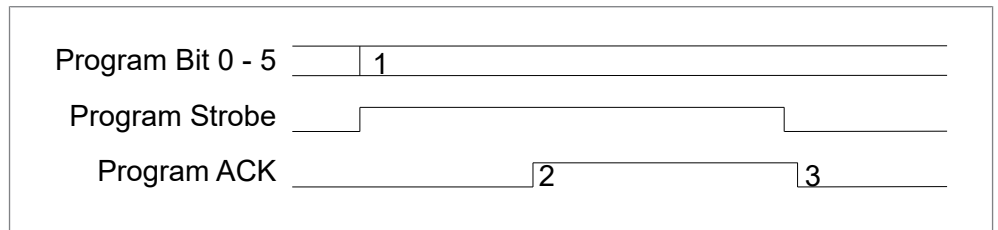

Fig. 8 Signal path diagram

1	Selected program via bits.
2	Delay time Strobe high ACK high maximum of 180 ms.
3	Delay time Strobe low ACK low 1 ms.

During transfer of the new parameters, the "Ready for measurement" signal is set to "low". Before the next measurement, the "Ready for measurement" signal must be checked for "high". The maximum delay time of "Strobe" to "Ready for measurement" is 600 ms.

I5	I4	I3	I2	I1	I0	Program
0	0	0	0	0	0	0
0	0	0	0	0	1	1
0	0	0	0	1	0	2
1	1	1	1	0	0	60
1	1	1	1	0	1	61
1	1	1	1	1	0	62
1	1	1	1	1	1	63

4.5.3 Environmental conditions

Description	Value
Temperature	Operation: 0 °C to +50 °C Storage: -20 °C to +60 °C
Relative humidity without condensation (acc. to RH2)	5 % to 80 %

Sensor Analog Standard Signals

Measuring is carried out by a sensor with a standardized process signal 0 to 10 V. The input is selected in the <Configuration> menu.

Description	Value
Nominal force	adjustable
Nominal distance	see Setting Nominal Force / Nominal Distance Parameters, Page 54.
A/D converter	16 bit = 65536 steps
Nominal load of resolution	Steps see A/D converter, 1 step (bit) = nominal load / steps
Accuracy of measurement	1 %
Max. sampling rate	2000 Hz (0.5 ms)

Supply Voltage Sensor

Description	Value
Auxiliary voltage	24 V \pm 5 %, max. 100 mA
Reference voltage	10 V \pm 1 % standard signal : 0 V to 10 V

Sensor with Standard Signal Output

Description	Value
Auxiliary voltage	+24 VDC \pm 5 %, max. 100 mA
Nominal signal	0 V to 10 V
Tare signal	0 V with zero adjustment, >9 V during measuring mode



With some types of force transducers or measurement amplifiers with tare function, a decrease of the measuring accuracy is possible after a certain period of time depending on the process.

DMS signals

Force measuring (channel Y) via DMS force transducer. The input is selected in menu <Configuration / Sensors>.

Description	Value
Nominal force	adjustable
Nominal distance	see Setting Nominal Force / Nominal Distance Parameters, Page 54.
A/D converter	16 bit = 65536 steps
Nominal load of resolution	65536 steps, 1 step (bit) = nominal load / 65536
Gain error	±0.5 %
Max. sampling rate	2000 Hz (0.5 ms)
Bridge voltage	10 V
Characteristic value	1.1 mV / V

5 Transport and storage

5.1 Temporary storages

- Use original packaging.
- Make sure that all electrical connections are covered to prevent dust ingress.
- Protect the display against sharp-edged objects e.g. due to cardboard or hard foam.
- Wrap the device, e.g. with a plastic bag.
- Store the device only in closed, dry, dust-free and dirt-free rooms at room temperature.
- Add drying agent to the packaging.

5.2 Dispatch for repair

To dispatch the product for repair to TOX® PRESSOTECHNIK, please proceed as follows:

- Fill in the "Accompanying repair form". This we supply in the service sector on our website or upon request via e-mail.
- Send us the completed form via e-mail.
- Then you will receive the shipping documents from us via e-mail.
- Send us the product with the shipping documents and a copy of the "Accompanying repair form".

For contact data see: [Chap. 1.6 Contact and source of supply, Page 11](#) or www.tox-pressotechnik.com.

6 Installation

6.1 Holding bracket

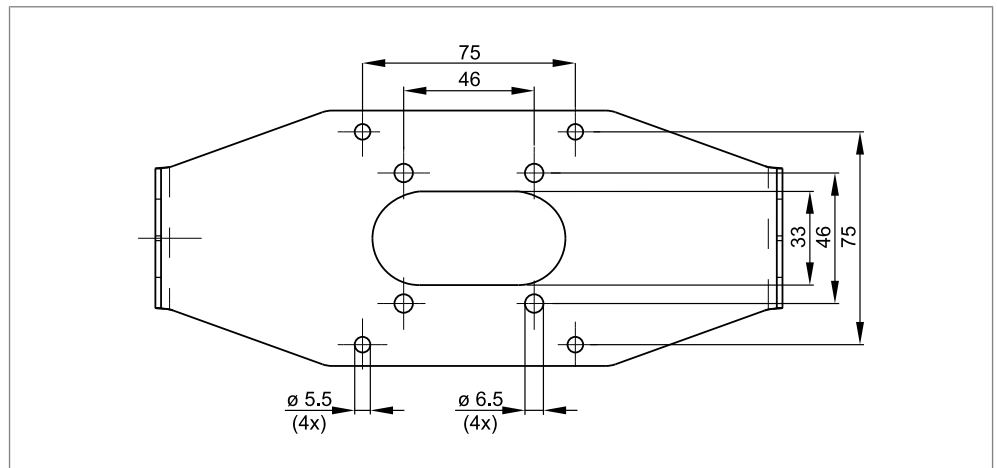

Fig. 9 Hole pattern of holding bracket

With the holding bracket the device to be used as a table, wall device or to be fixed to an outrigger.

7 Commissioning

7.1 Preparing System

1. Check installation and mounting.
2. Connect required lines and devices, e.g. sensors and actuators.
3. Connect supply voltage.
4. Make sure that the correct supply voltage is connected.
See [Chap. 4.4 Interfaces, Page 23](#).

7.2 Starting system

- ✓ System is prepared.
See [Chap. 7.1 Preparing System, Page 39](#).
- ➔ Switch on the plant.
- ▶ The device starts the operating system and the application.
- ▶ The device switches to the start screen.

8 Operation

8.1 Monitoring operation

No operating steps are necessary during ongoing operation.



The operating procedure must be monitored constantly in order to detect faults in time.

9 Software

9.1 Function of the Software

The software fulfils the following functions:

- Clear representation of the operating parameters for operation monitoring
- Displaying of fault messages and warnings
- Configuration of the operating parameters by setting individual operating parameters
- Configuration of the interface by setting the software parameters

9.2 Software interface

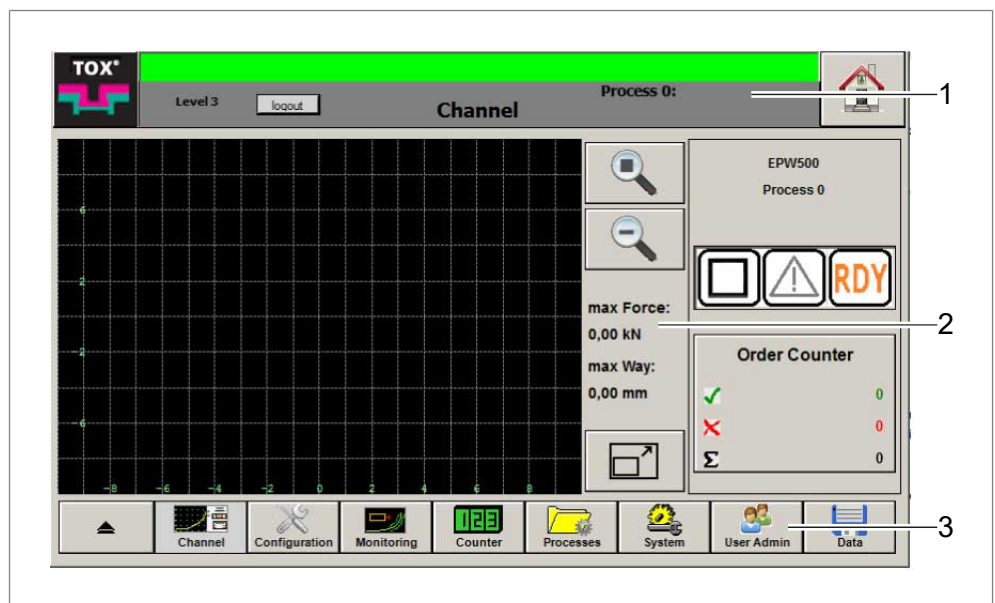

Fig. 10 Software interface

	Screen area	Function
1	Information and status bar	The information and display bar displays: <ul style="list-style-type: none"> • General information on the pressing monitor • Current pending messages and information for the main area displayed in the screen.
2	Menu-specific screen area	The menu-specific screen area displays the specific contents for the screen currently open.
3	Menu bar	The menu bar displays the specific sub-menus for the menu currently open.

9.2.1 Information and status bar

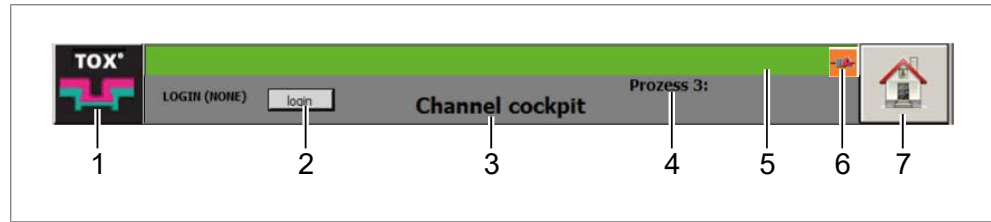

Fig. 11 Information and status bar

	Display/control panel	Function
1	Call up "System / Version" menu	Opens "System / Version" menu
2	Call up access authorization	Opens login dialog
3	Display of current menu	
4	Display of current process	
5	Information and status display	
6	Warning symbol	Displays connection problems with external memory expansion
7	Start screen	Opens "Canal Cockpit" menu

9.3 Control elements

9.3.1 Function buttons

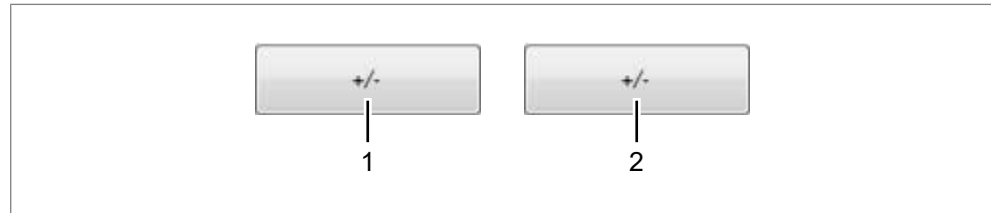

Fig. 12 Function buttons

	Display/control panel	Function
1	Normal	
2	Highlighted (with a grey background)	

9.3.2 Checkboxes

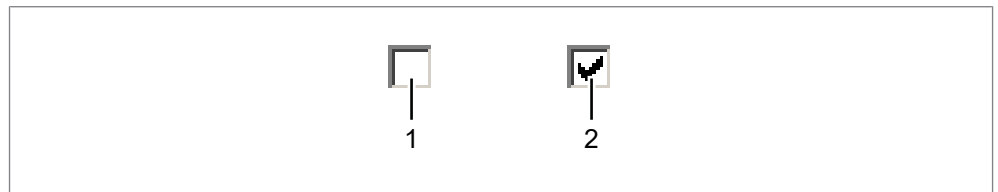

Fig. 13 Checkboxes

	Display/control panel	Function
1	Not selected	
2	Selected	

9.3.3 Selection lists

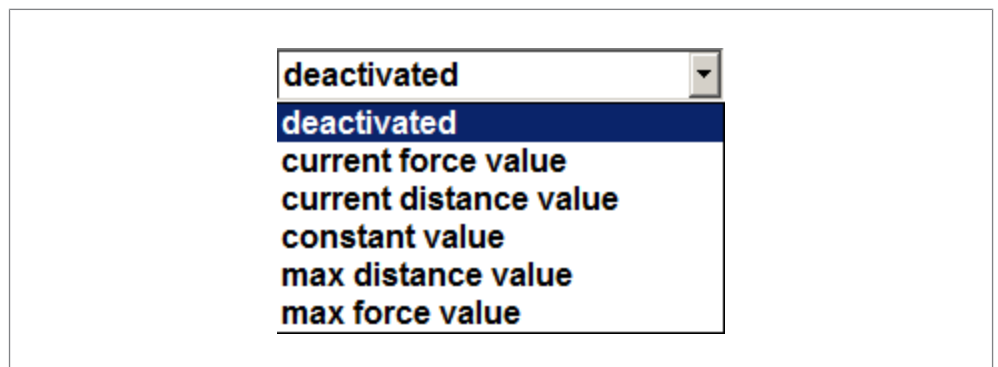

Fig. 14 Selection lists

A value can be selected from a specified list of values via the selection list.

9.3.4 Input field

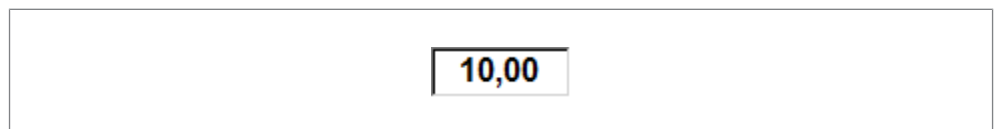

Fig. 15 Input field

The input field has two functions.

- The input field displays the value currently entered.
- Values can be entered or changed in an input field. This function is dependent on the user level and is not normally available for all user levels.

9.3.5 Dialog keyboard

Keyboard dialogs are needed for entering and changing values in input fields.

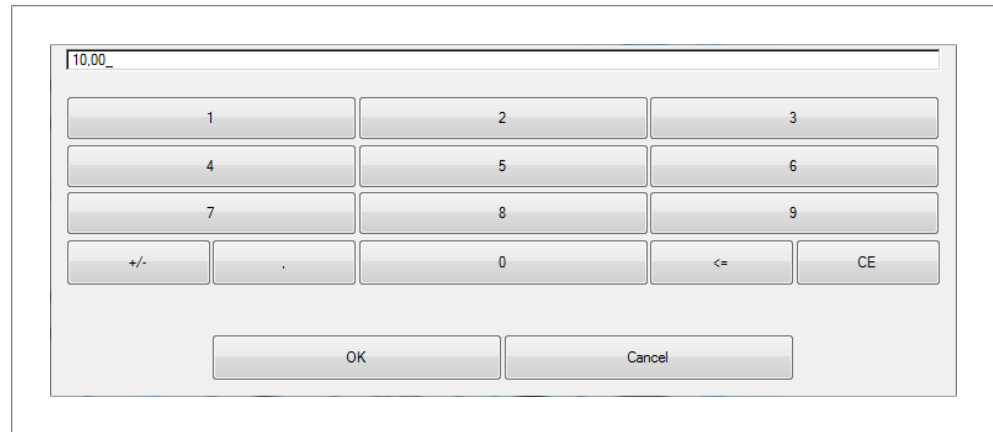

Fig. 16 Numerical keyboard

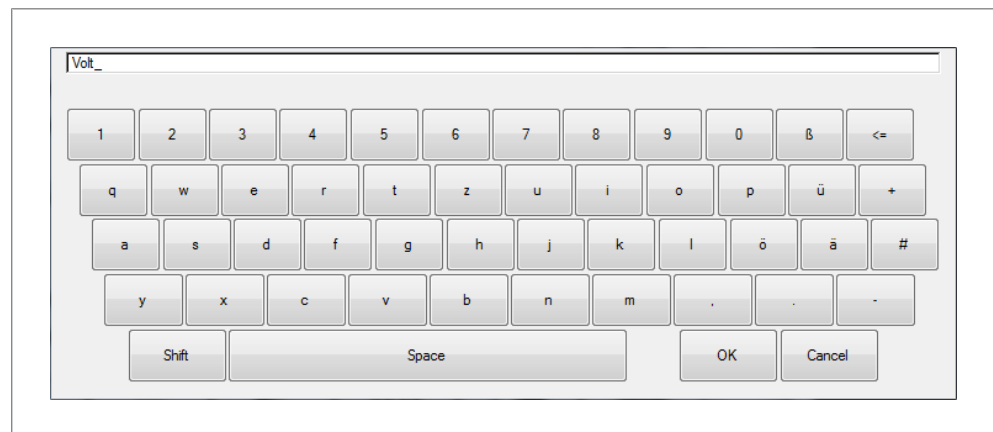

Fig. 17 Alphanumeric keyboard

It is possible to switch between four modes with the alphanumeric keyboard:

- Permanent lowercase
- Uppercase and special characters for the next entry
- Permanent uppercase and special characters
- Other special characters

Activating permanent lowercase

→ Press **Shift** button until the keyboard displays lowercase letters.

Activating uppercase and special characters for the next entry

- ✓ "permanent" lowercase mode is activated. The keyboard only displays lowercase letters and numbers.
- ➔ Press **Shift** button once.
- ▶ The keyboard displays uppercase letters and special characters.
- ▶ After entering a character, the keyboard returns again to the "permanent" lowercase mode.

Activating permanent uppercase and special characters

- ✓ "permanent" lowercase mode is activated. The keyboard only displays lowercase letters and numbers.
- ➔ Press **Shift** two times.
 - ▷ The lettering "Shift" becomes red and is underlined.
 - ▷ The keyboard displays uppercase letters and special characters.
 - ▷ Any number of uppercase letters or special characters can be entered.

Activating other special characters

- ✓ "permanent" lowercase mode is activated. The keyboard only displays lowercase letters and numbers.
- ➔ Press **Shift** three times.
 - ▶ The keyboard displays other special characters, e.g. "€".
 - ▶ After entering a character, the keyboard returns again to the "permanent" lowercase mode.

9.3.6 Saving Changes Dialog

The "Save changes" dialog appears if a menu should be exited without saving changes beforehand.

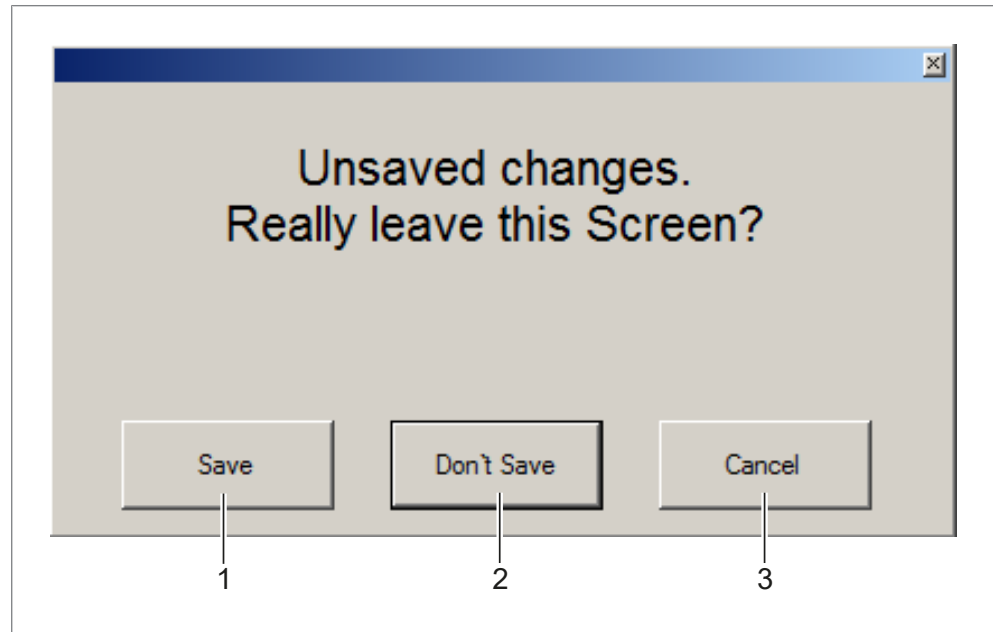









Fig. 18 "Save changes" dialog

	Display/control panel	Function
1	Save	The changed values are saved and the current menu is exited.
2	Do not save	The changed values are discarded and not saved. The current menu is exited.
3	Cancel	Cancellation of the action. Returns to the current menu.

9.3.7 Icons

	Display/control panel	Function
	Measure OK	The last measurement was OK.
	Measured result undefined	The measured result is not yet known.
	Measurement NOK	Last measurement was not OK. At least one evaluation criteria was violated (envelope curve, window).
	No message	No messages are pending.
	Warning	One warning is pending.
	Fault	One error is pending.
	Device ready to measure	Pressing monitor is ready to start a measurement.
	Device not ready to measure	Pressing monitor is not ready to start a measurement.
	Measure active	The measurement is in progress.

9.4 Main menus

9.4.1 Channel cockpit

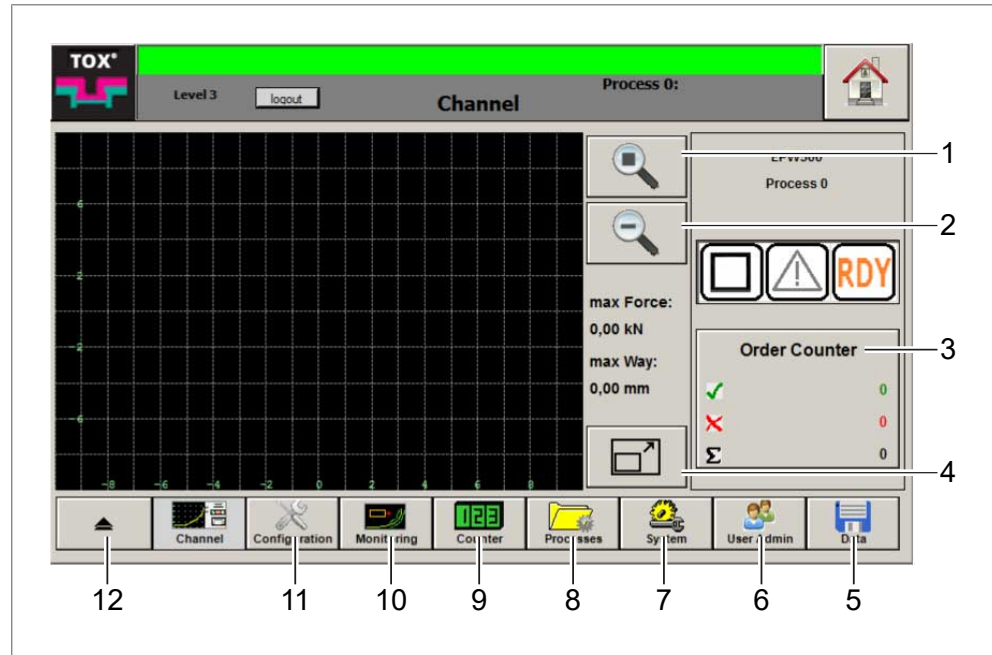

Fig. 19 Menu "Channel cockpit"

	Display/control panel	Function
1	User zoom	Restores user zoom
2	Reduce zoom factor	Reduces zoom factor
3	Job counter	Counter \ ... that is displayed in the start screen.
4	Full-screen display	Changes to full-screen display see Full-screen display, Page 51 .
5	Data	Opens Data menu
6	User	Opens User menu
7	System	Opens System menu
8	Processes	Opens Processes menu
9	Counters	Opens Counter menu
10	Monitoring	Opens Monitoring menu
11	Configuration	Opens Configuration menu
12	Menu back	Changes to the higher menu

9.4.2 Full-screen display

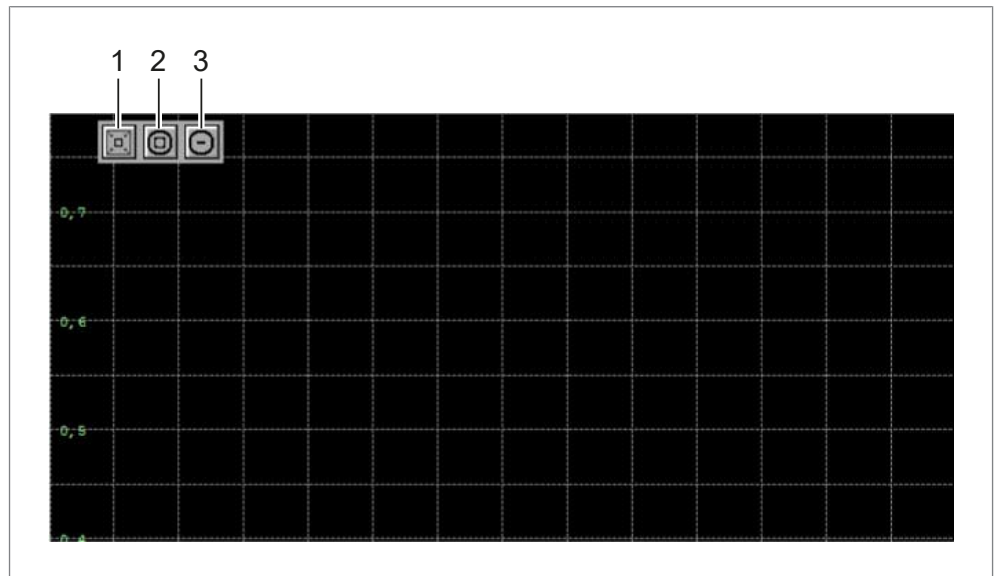

Fig. 20 Menu "Full-screen display"

	Display/control panel	Function
1	Full-screen display	Closes the full-screen display
2	User zoom	Restores user zoom
3	Zoom factor	Reduces zoom factor

9.4.3 Status window

The status window displays all configured information about the work process.

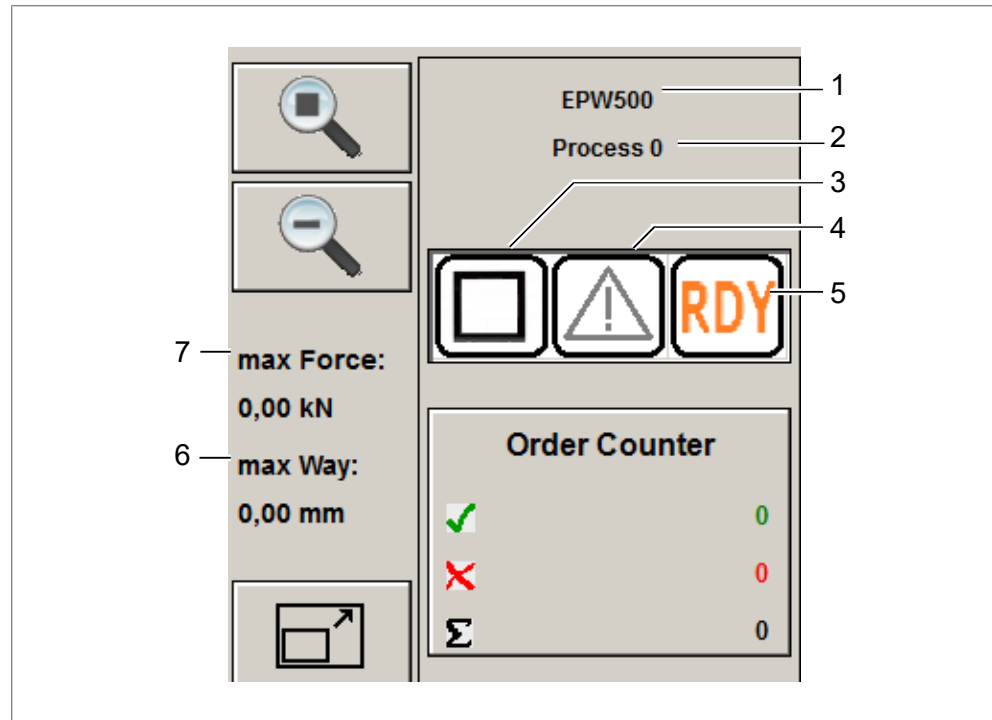

Fig. 21 Status window

	Display field
1	Device name
2	Current process
3	Measured result
4	Messages (warning / error)
5	Process monitoring system ready to measure
6	Maximum distance of the last work process
7	Maximum force of the last work process

9.4.4 Configuration

All settings in the "Configuration" menu can be customized for every single process.

Sensors

The nominal force, nominal distance and offset of the sensors are set in the "Configuration\Sensors" menu. Furthermore, the sensors connected to the pressing monitor are calibrated.

Sensors have to be calibrated if they were replaced or if the system should be recalibrated.



In these instructions, the nominal force is specified in kN and the nominal distance is specified in mm.

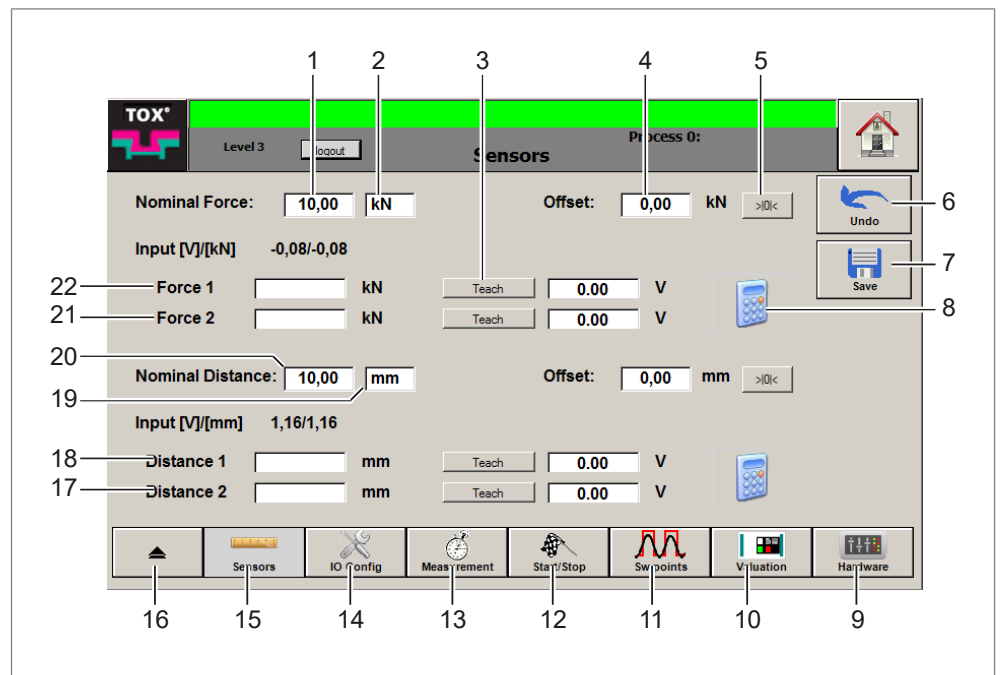

Fig. 22 Menu "Configuration \ Sensors"

	Button	Function
3	Teach	Reads in the actual value of the force or distance sensor
5	Offset	Offset adjustment
6	Undo	Undoes the entry
7	Save	Saves the entry
8	Calibration	Determines the calibration
9	Hardware	Opens Hardware menu
10	NOK options	Opens Evaluation Options menu
11	Switching points	Opens Switching points menu

	Button	Function
12	Start/Stop	Opens Start/Stop menu
13	Measuring parameters	Opens Measuring parameters menu
14	IO Config	Opens IO Config menu
15	Sensors	Opens Sensors menu
16		Changes to the higher menu

	Input fields	Function
1	Nominal force (value)	Max. force of the force sensor at max. measurement signal.
2	Nominal force (unit)	Measurement unit of the force sensor (max. 4 characters).
4	Offset	Offset for the corresponding sensor.
17	Distance 2	Measurement value of the 2nd measurement point
18	Distance 1	Measurement value of the 1st measurement point
19	Nominal distance (unit)	Measurement unit of the distance sensor (max. 4 characters).
20	Nominal distance (value)	Max. distance of the distance sensor at max. measurement signal.
21	Force 2	Measurement value of the 2nd measurement point.
22	Force 1	Measurement value of the 1st measurement point

Setting Nominal Force / Nominal Distance Parameters

When setting up the pressing monitor, the **nominal force** and **nominal distance** parameters must be defined in order to evaluate the measurement values correctly.

- ✓ The user is logged in with a suitable user level. The necessary write permissions are available.
1. Tap on **Nominal force** input field.
 - ▷ The numerical keyboard opens.
 2. Enter max. nominal force and press the **OK** button to confirm.
 3. Tap on **Nominal force \ Unit** input field.
 - ▷ The alphanumeric keyboard opens.
 4. Enter unit and press the **OK** button to confirm.
 5. Repeat steps 1 to 4 for the **Nominal distance** parameter.
 6. Tap on **Save** button to save the values.

Adjusting Force Sensor or Distance Sensor Offset

The **Offset** parameter adjusts a possible zero point offset of the analog measurement sensor of the sensor.

An offset adjustment must be carried out:

- once a day or after approx. 1000 measurements.
- when a sensor has been changed.

Adjustment using Offset adjustment button

- ✓ The user is logged in with a suitable user level. The necessary write permissions are available.
- ✓ Sensor is load-free during the offset adjustment.

1. Tap on **Offset adjustment** button.
 - ▷ The current measurement signal (V) is applied as offset.
2. Tap on **Save** button to save the values.

Adjustment via direct Value Input

- ✓ The user is logged in with a suitable user level. The necessary write permissions are available.
- ✓ Sensor is load-free during the offset adjustment.

1. Tap on **Offset** input field.
 - ▷ The numerical keyboard opens.
2. Enter zero point value and press the **OK** button to confirm.
3. Tap on **Save** button to save the values.

Calibrating Sensors

Sensors have to be recalibrated if they were replaced or if the system should be recalibrated.

The sensors are calibrated after the two-point calibration process. During the two-point calibration, the exact linear path of the measurement chain characteristic is determined via two measurement points. In this way, the gradient and offset of the measurement chain characteristic is determined.

- ✓ The user is logged in with a suitable user level. The necessary write permissions are available.
 - ✓ The reference measuring instrument is connected.
1. Move to first measurement point.
 2. Apply value using **Teach** button.
 3. Tap on **Force 1** or **Distance 1** input field
 - ▷ The numerical keyboard opens.
 4. Enter displayed value on the reference measuring instrument and press the **OK** button to confirm.
 5. Move to second measurement point.
 6. Apply value using **Teach** button.
 7. Tap on **Force 2** or **Distance 2**
 - ▷ The numerical keyboard opens.
 8. Enter displayed value of the reference measuring instrument and press the **OK** button to confirm.
 9. Apply value using **Calibration** button.
 - ▷ The gradient and offset between both measurement points are calculated.
 10. Tap on **Save** button to save the values.

IO Config

The inputs of the sensors and the outputs are configured in the "Configuration \ IO Config" menu.

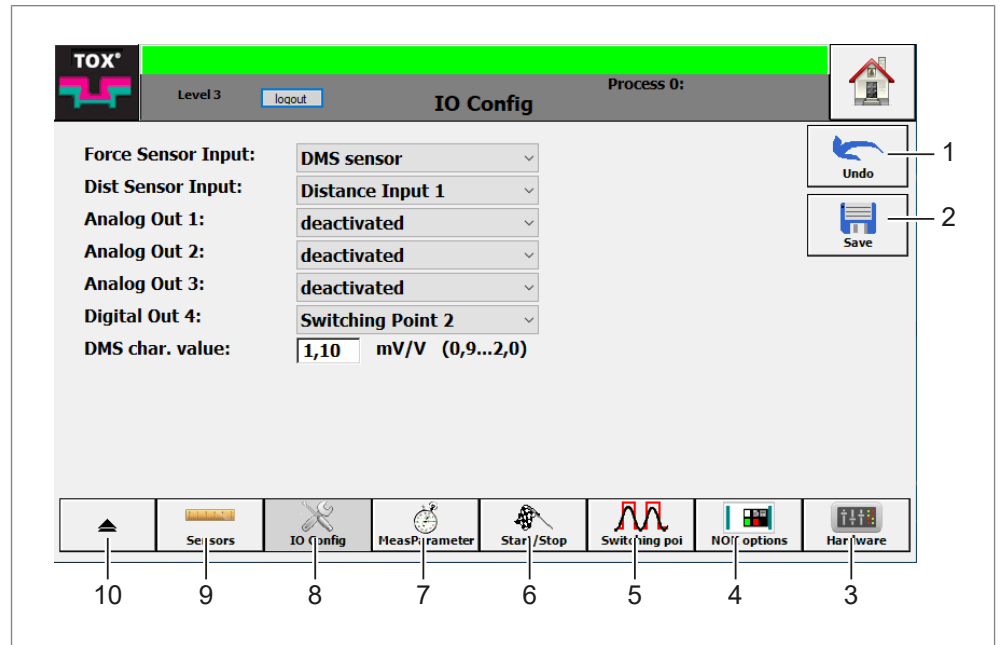

Fig. 23 "Configuration \ IO Config" menu

	Button	Function
1	Undo	Undoes the entry
2	Save	Saves the entry
3	Hardware	Opens Hardware menu
4	Evaluation Options	Opens Evaluation Options menu
5	Switching points	Opens Switching points menu
6	Start/Stop	Opens Start/Stop menu
7	Measuring parameters	Opens Measuring parameters menu
8	IO Config	Opens IO Config menu
9	Sensors	Opens Sensors menu
10		Changes to the higher menu

Configuring Inputs/Outputs

- ✓ The user is logged in with a suitable user level. The necessary write permissions are available.
1. Tap on selection field of the input or output.
 - ▷ Selection list opens.
 2. Select value.
 3. Tap on **Save** button to save the values.

DMS Characteristic Value

The characteristic for the DMS force transducer is entered using the **Characteristic value** parameter.

- ✓ The user is logged in with a suitable user level. The necessary write permissions are available.
- ✓ DMS sensor is selected at the force sensor input.

1. Tap on **DMS Characteristic Value** input field.
 - ▷ The numerical keyboard opens.
2. Enter characteristic value and press the **OK** button to confirm.
3. Tap on **Save** button to save the values.

Measuring parameters

In the "Configuration \ Measuring parameters" menu, the type of measurement data acquisition is configured via the **acquisition type** parameter. The following modes are available:

- Distance rising
- Distance rising or falling
- Force or distance increasing
- Force or distance change
- Time-triggered

Selecting <Distance rising> Mode

This mode is suitable for positive value changes, e.g. clinch applications or pressing applications. The measurement values are measured at maximum sampling rate (2000 Hz). The measurement values are read in if the distance to the measurement value last read in has increased by the X-step entered.

If an end force is still increasing without a change in distance (block force), the values (max. force/distance) can be read in and the curve can be inserted via the <insert max. force at the end of the curve> function.

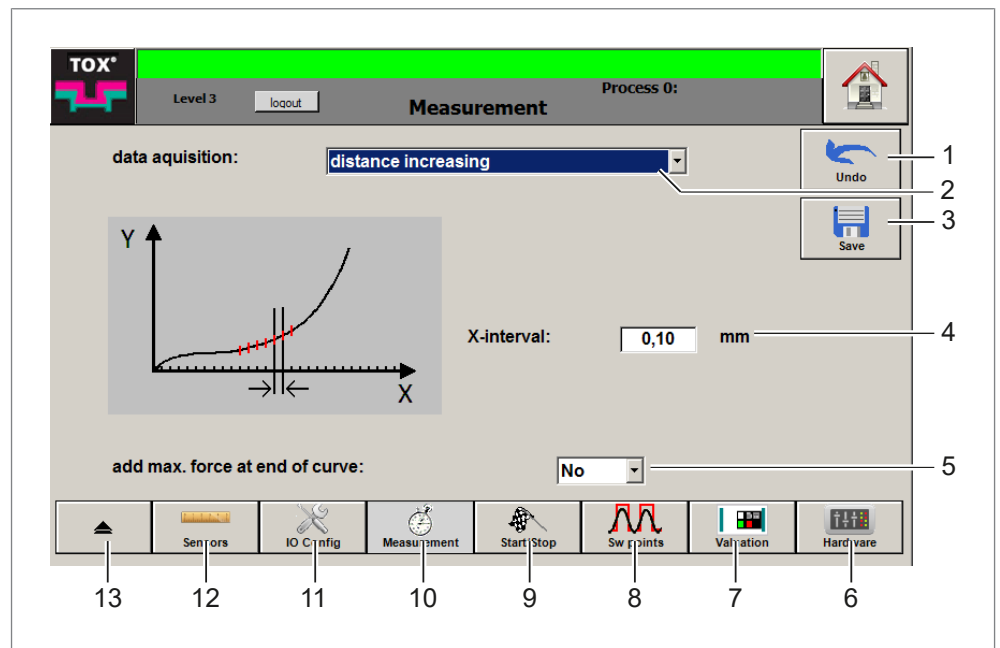

Fig. 24 "Measuring parameters" menu, **Distance rising** mode

	Button	Function
1	Undo	Undoes the entry
3	Save	Saves the entry
6	Hardware	Opens Hardware menu
7	Evaluation Options	Opens Evaluation Options menu
8	Switching points	Opens Switching points menu
9	Start/Stop	Opens Start/Stop menu
10	Measuring parameters	Opens Measuring parameters menu
11	IO Config	Opens IO Config menu
12	Sensors	Opens Sensors menu
13		Changes to the higher menu

	Input fields	Function
2	Acquisition type	Max. force of the force sensor at max. measurement signal
4	X-Step	Minimum change in distance to the value last read in
5	Insert max. force at the end of the curve	Display end force (block force) at the end of the curve

✓ The user is logged in with a suitable user level. The necessary write permissions are available.

1. Tap on **Acquisition type** input field and select **Distance rising** mode.
2. Tap on **X-step** input field.
 - ▷ The numerical keyboard opens.
3. Enter value in [mm] and press the **OK** button to confirm.
4. Tap on **Insert max. force at the end of the curve** input field and select whether the force should be inserted or not.
5. Tap on **Save** button to save the values.

Select <Distance rising or falling> mode

This mode is recommended if negative distance changes should be also recorded, e.g. applications with snap-back effects. The measurement values are measured at maximum sampling rate (2000 Hz). The measurement values are read in if the distance in positive or negative direction to the measurement value last read in has changed by the X-step that was read in.

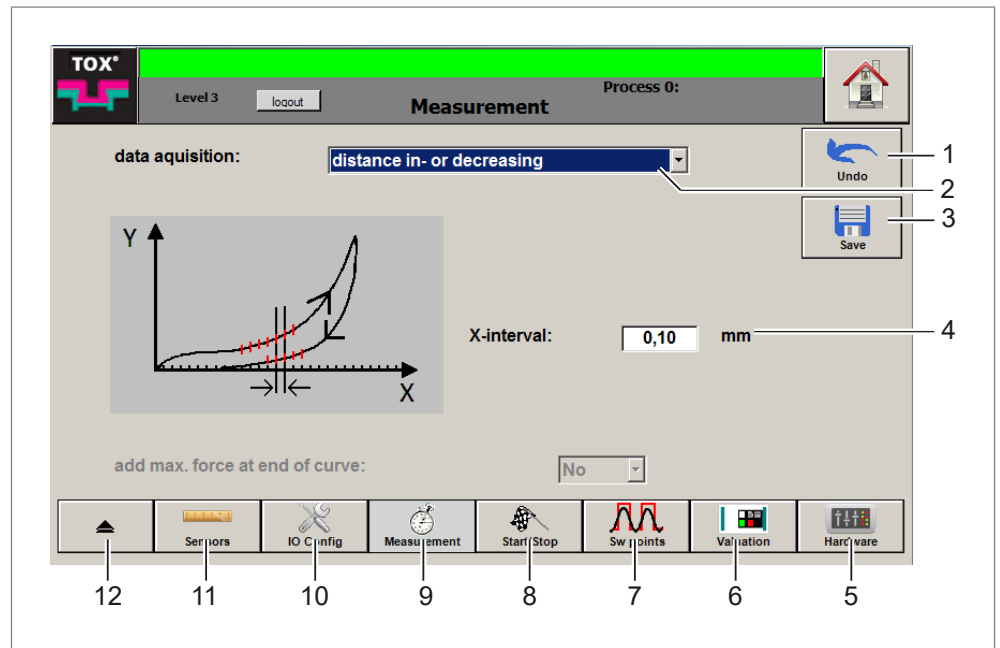

Fig. 25 "Measuring parameters" menu, **Distance rising or falling** mode

	Button	Function
1	Undo	Undoes the entry
3	Save	Saves the entry
5	Hardware	Opens Hardware menu
6	Evaluation Options	Opens Evaluation Options menu
7	Switching points	Opens Switching points menu
8	Start/Stop	Opens Start/Stop menu
9	Measuring parameters	Opens Measuring parameters menu
10	IO Config	Opens IO Config menu
11	Sensors	Opens Sensors menu
12		Change to the higher menu

	Input fields	Function
2	Acquisition type	Max. force of the force sensor at max. measurement signal
4	X-Step	Minimum change in distance to the value last read in

- ✓ The user is logged in with a suitable user level. The necessary write permissions are available.

- 1. Tap on **Acquisition type** input field and select **Distance rising or falling** mode.
- 2. Tap on **X-step** input field.
 - ▷ The numerical keyboard opens.
- 3. Enter value in [mm] and press the **OK** button to confirm.
- 4. Tap on **Save** button to save the values.

Select <Force or distance rising> mode

This mode is recommended for positive force or distance changes. In this mode, a pair of values is read in if since the last pair of values that was read in ...

- the distance has increased by the X-step.
- the force has increased in positive direction.

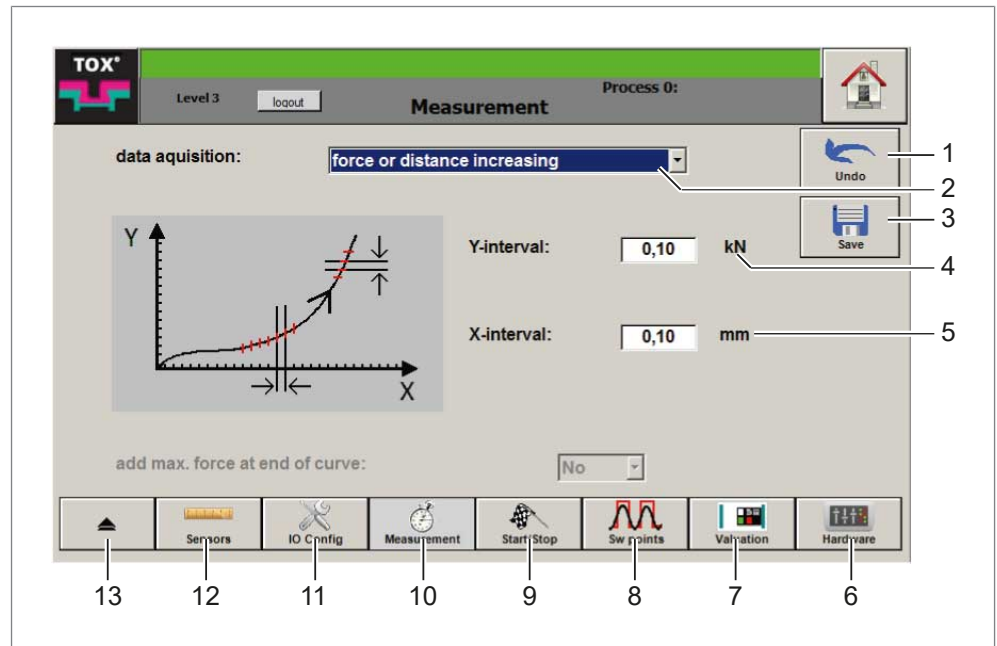

Fig. 26 "Measuring parameters" menu, **Force or distance rising** mode

	Button	Function
1	Undo	Undoes the entry
3	Save	Saves the entry
6	Hardware	Opens Hardware menu
7	Evaluation Options	Opens Evaluation Options menu
8	Switching points	Opens Switching points menu
9	Start/Stop	Opens Start/Stop menu
10	Measuring parameters	Opens Measuring parameters menu
11	IO Config	Opens IO Config menu
12	Sensors	Opens Sensors menu
13		Change to the higher menu

	Input fields	Function
2	Acquisition type	Max. force of the force sensor at max. measurement signal
4	Y-Step	Minimum change in force to the value last read in
5	X-Step	Minimum change in distance to the value last read in

- ✓ The user is logged in with a suitable user level. The necessary write permissions are available.

- 1. Tap on **Acquisition type** input field and select **Force or distance rising** mode.
- 2. Tap on **Y-step** input field.
 - ▷ The numerical keyboard opens.
- 3. Enter value in [kN] and press the **OK** button to confirm.
- 4. Tap on **X-step** input field.
 - ▷ The numerical keyboard opens.
- 5. Enter value in [mm] and press the **OK** button to confirm.
- 6. Tap on **Save** button to save the values.

Select <Force or distance change> mode

This mode is recommended if the force can change while no distance changes occur, e.g. for applications with large slip-in effects. In this mode, a pair of values is read in if since the last pair of values that was read in ...

- the distance has changed in positive or negative direction by the X-step.
- the force has changed in positive or negative direction by the Y-step.

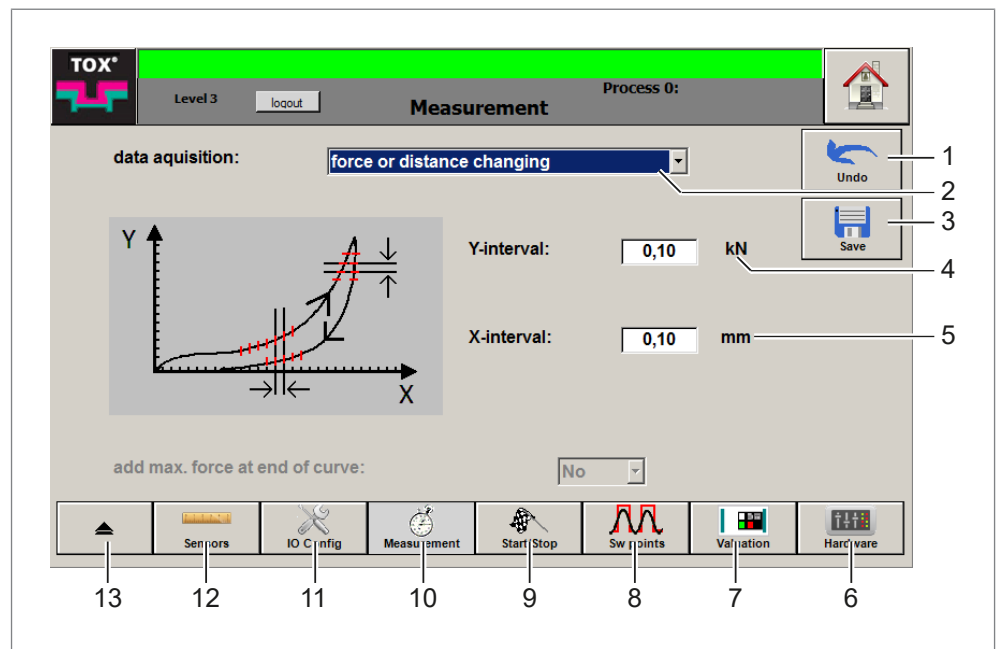

Fig. 27 "Measuring parameters" menu, Force or distance change mode

	Button	Function
1	Undo	Undoes the entry
3	Save	Saves the entry
6	Hardware	Menu Hardware
7	Evaluation Options	Opens Evaluation Options menu
8	Switching points	Opens Switching points menu
9	Start/Stop	Opens Start/Stop menu
10	Measuring parameters	Opens Measuring parameters menu
11	IO Config	Opens IO Config menu
12	Sensors	Opens Sensors menu
13		Change to the higher menu

	Input fields	Function
2	Acquisition type	Max. force of the force sensor at max. measurement signal
4	Y-Step	Minimum change in force to the value last read in
5	X-Step	Minimum change in distance to the value last read in

- ✓ The user is logged in with a suitable user level. The necessary write permissions are available.

- 1. Tap on **Acquisition type** input field and select **Force or distance change** mode.
- 2. Tap on **Y-step** input field.
 - ▷ The numerical keyboard opens.
- 3. Enter value in [kN] and press the **OK** button to confirm.
- 4. Tap on **X-step** input field.
 - ▷ The numerical keyboard opens.
- 5. Enter value in [mm] and press the **OK** button to confirm.
- 6. Tap on **Save** button to save the values.

Selecting <time-triggered> Mode

In this mode, all values are read in time-controlled at the specified frequency. This mode is recommended if the other modes do not lead to any satisfactory results. At a sampling of 2000 Hz, the buffer is filled after approx. 2.5 s. The smaller the sampling rate, the longer the sampling data can be written into the buffer.

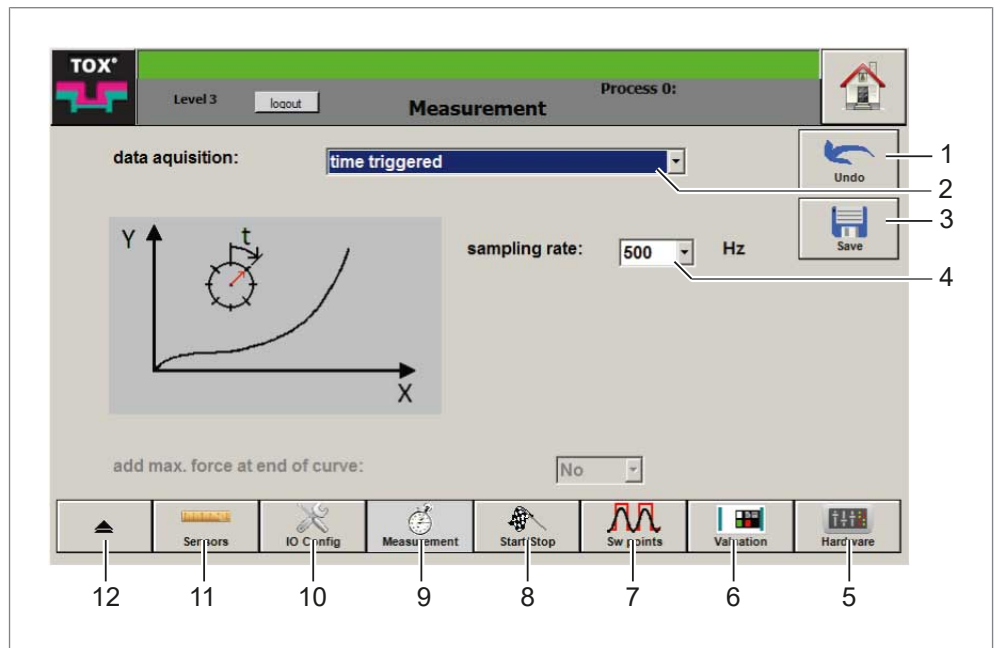

Fig. 28 "Measuring parameters" menu, **time-triggered** mode

	Button	Function
1	Undo	Undoes the entry
3	Save	Saves the entry
5	Hardware	Opens Hardware menu
6	Evaluation Options	Opens Evaluation Options menu
7	Switching points	Opens Switching points menu
8	Start/Stop	Opens Start/Stop menu
9	Measuring parameters	Opens Measuring parameters menu
10	IO Config	Opens IO Config menu
11	Sensors	Opens Sensors menu
12		Change to the higher menu

	Input fields	Function
2	Acquisition type	Max. force of the force sensor at max. measurement signal
4	Sampling rate	Sampling rate for the measurements

- ✓ The user is logged in with a suitable user level. The necessary write permissions are available.
1. Tap on **Acquisition type** input field and select **Time-triggered** mode.
 2. Tap on **sampling rate** input field.
 - ▷ A drop-down list opens.
 3. Select sampling rate in [Hz].
 4. Tap on **Save** button to save the values.

Start/Stop

In the "Start/Stop" menu, you set when and how the measurement should be started and stopped.

The illustrated screens serve as examples. The start / stop types provided can be combined with each other.

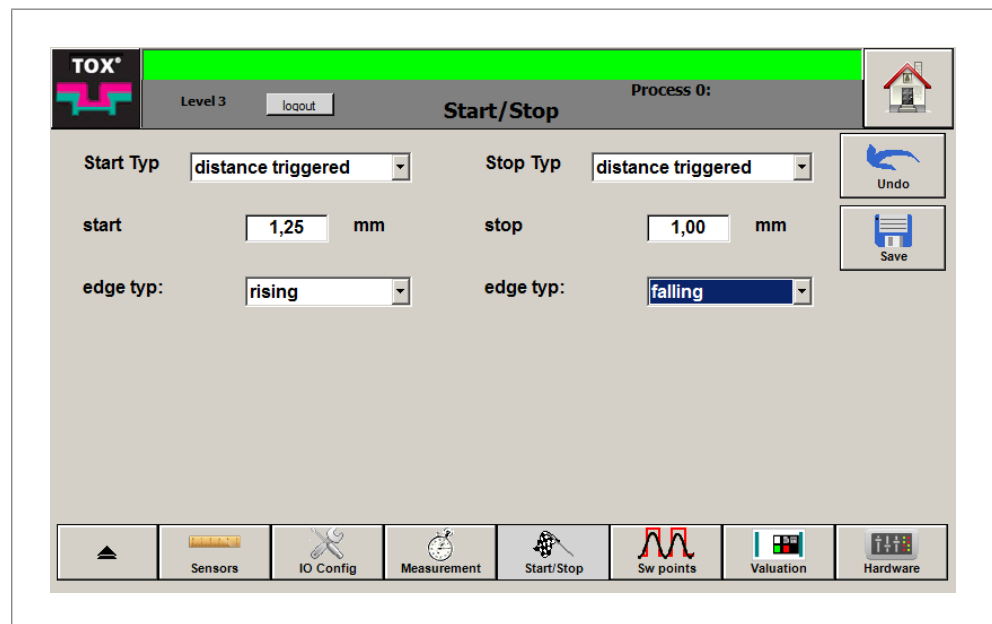

Fig. 29 "Configuration \ Start/Stop" menu

The following modes are available:

- Distance-triggered
- Force-triggered
- Digital IN triggered
- Time-triggered (only available with stop type)

Selecting <Distance-triggered> Mode

A measurement is started or stopped as soon as the distance set under **Start** or **Stop** is exceeded or fallen short of edge-dependent.

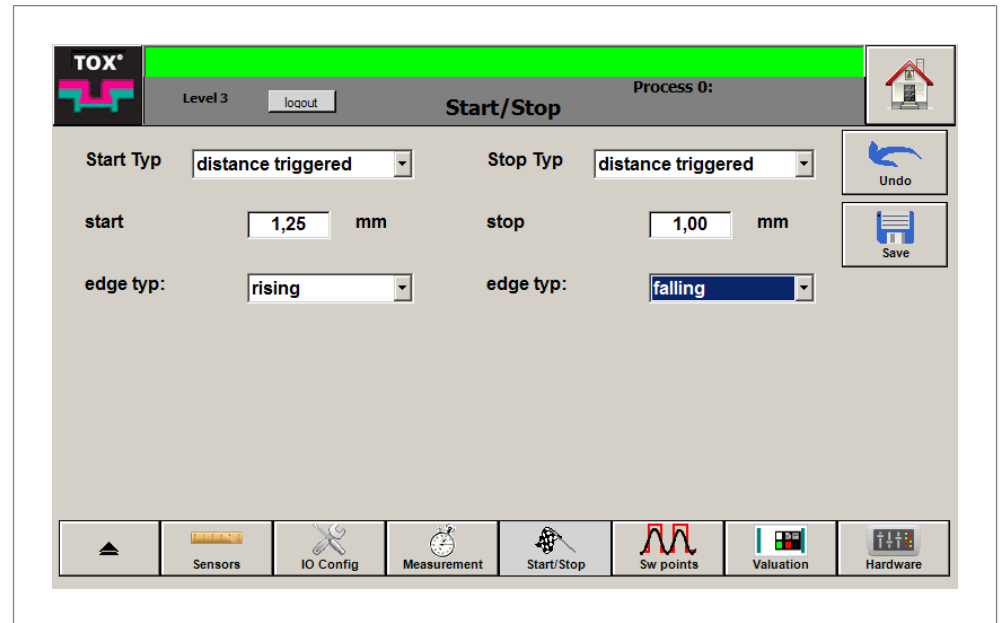

Fig. 30 "Configuration \ Start/Stop" menu

- ✓ The user is logged in with a suitable user level. The necessary write permissions are available.
1. Tap on **Start type** or **Stop type** selection field and select **distance-triggered**.
 2. Tap on **Start** or **Stop** input field
 - ▷ The numerical keyboard opens.
 3. Enter value in [mm] and press the **OK** button to confirm.
 4. Tap on **edge type** selection field and select whether the Start or Stop of the measurement should begin with rising or falling edge.
 5. Tap on **Save** button to save the values.

Selecting <Force-triggered> Mode

A measurement is started or stopped as soon as the force set under **Start** or **Stop** is exceeded or fallen short of edge-dependent.

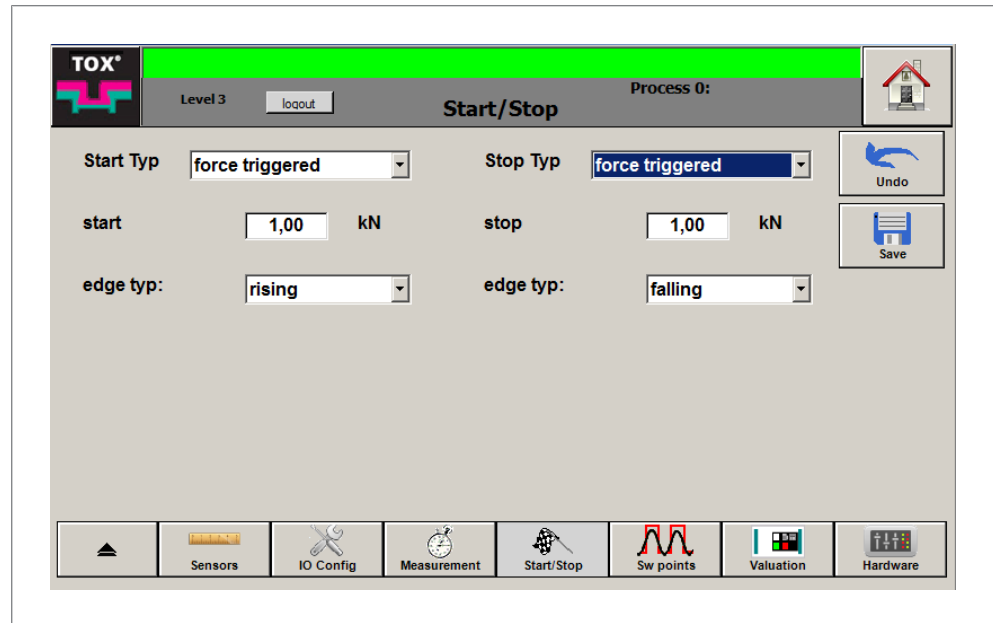

Fig. 31 "Configuration \ Start/Stop" menu

- ✓ The user is logged in with a suitable user level. The necessary write permissions are available.
- 1. Tap on **Start type** or **Stop type** selection field and select **force-triggered**.
- 2. Tap on **Start** or **Stop** input field
 - ▷ The numerical keyboard opens.
- 3. Enter value in [kN] and press the **OK** button to confirm.
- 4. Tap on **edge type** selection field and select whether the Start or Stop of the measurement should begin with rising or falling edge.
- 5. Tap on **Save** button to save the values.

Selecting <Digital IN triggered>

A measurement is started or stopped via the digital signal.

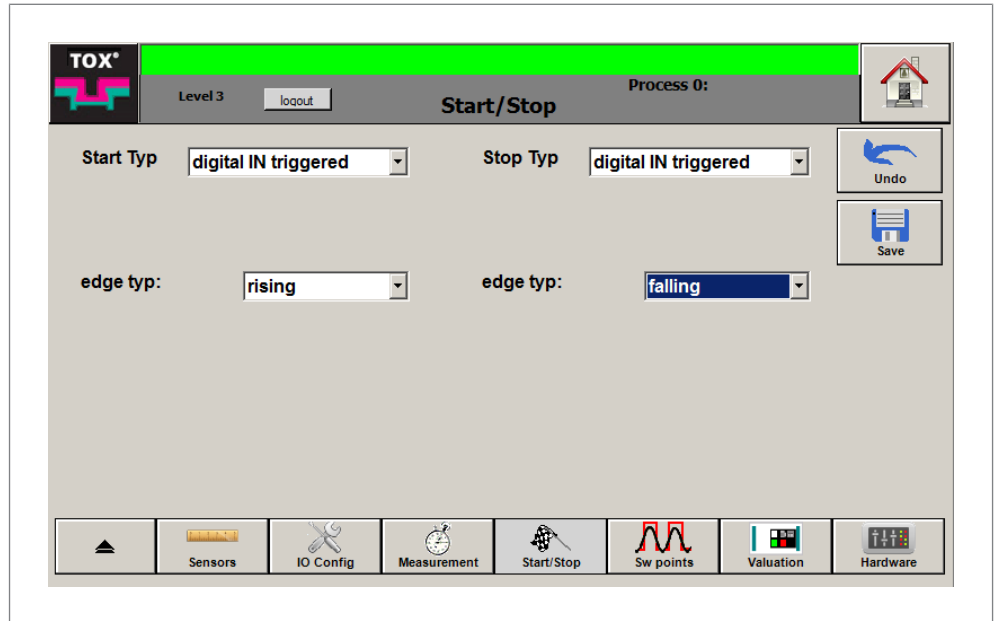

Fig. 32 "Configuration \ Start/Stop" menu

- ✓ The user is logged in with a suitable user level. The necessary write permissions are available.
1. Tap on **Start type** or **Stop type** selection field and select **Digital IN triggered**.
 2. Tap on **edge type** selection field and select whether the Start or Stop of the measurement should begin with rising or falling edge.
 3. Tap on **Save** button to save the values.

Selecting <time-triggered> Mode

A measurement can only be stopped time-triggered.

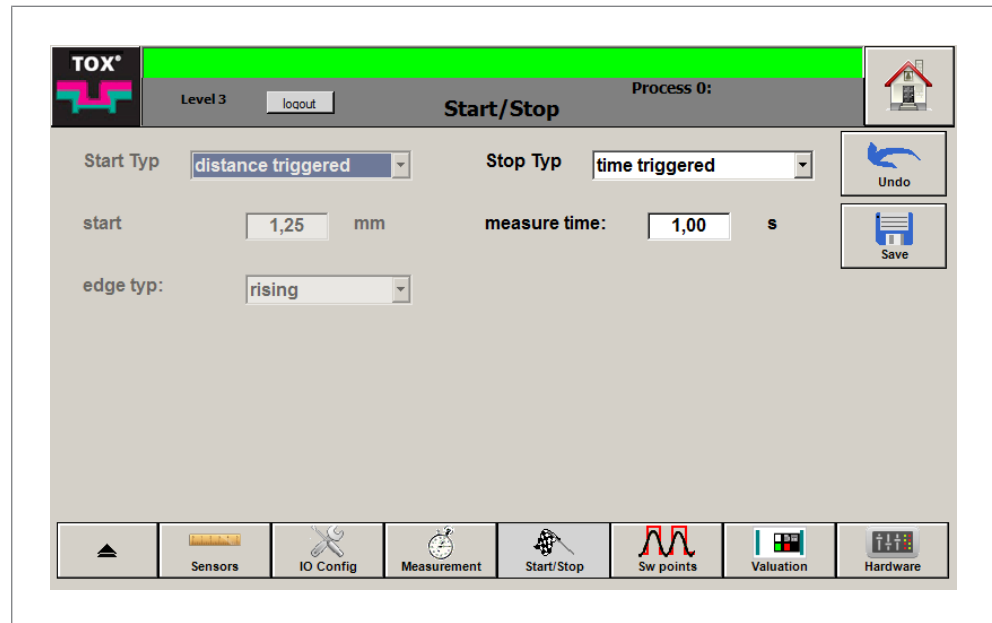

Fig. 33 "Configuration \ Start/Stop" menu

- ✓ The user is logged in with a suitable user level. The necessary write permissions are available.
1. Tap on **Start type** or **Stop type** selection field and select **time-triggered**.
 2. Tap on **Measurement duration** input field
 - ▷ The numerical keyboard opens.
 3. Enter value in [s] after which the measurement should be stopped and press the **OK** button to confirm.
 4. Tap on **Save** button to save the values.

Configuring Switching Points

Several switching points are available, which can be used for different signals (force or distance). The setting for the current program can be copied into other programs.

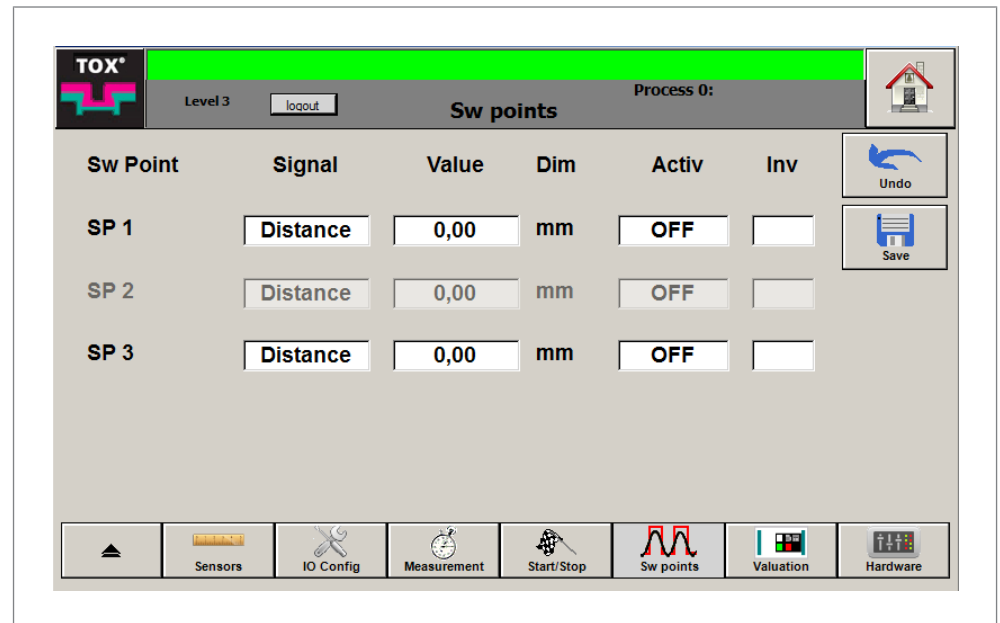

Fig. 34 "Configuration \ Switching points" menu



The **SP2** switching point can be activated or deactivated via the "IO config" menu. If the switching point is grayed out, the <NOK beeper> function was assigned to the <Digital Out 4> output.

- ✓ The user is logged in with a suitable user level. The necessary write permissions are available.
1. Tap on **Signal** field and set the switching point to the required signal.
 - ▷ The displayed signal switches between **distance** and **force**.
 2. Tap on **value** input field.
 - ▷ The numerical keyboard opens.
 3. Enter value in the corresponding dimension and press the **OK** button to confirm
 4. Tap on **Inv** field and set the switching point to inverse (X) or normal.
 5. Tap on **Active** field and activate switching point (ON) or deactivate (OFF).
 6. Tap on **Save** button to save the values.

NOK options

If an acknowledgement type was selected, a NOK must be acknowledged before the pressing monitor is ready to measure again.

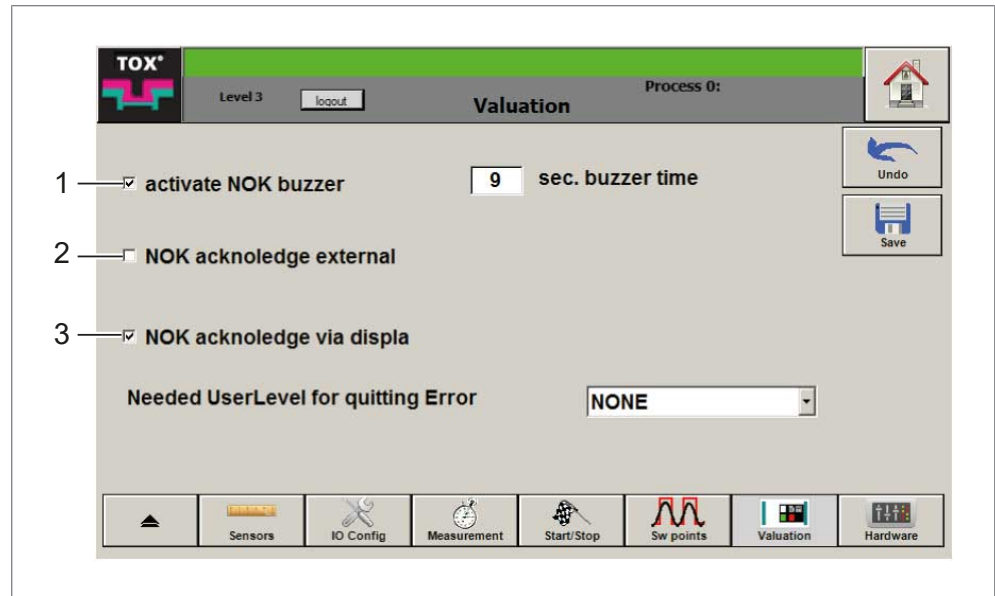

Fig. 35 "Configuration \ NIO options" menu

	Button	Function
1	activate NOK buzzer	If an external buzzer is connected, an acoustic signal always sounds in the case of NOK.
2	External NOK acknowledgement	The NOK message must always be acknowledged via an external signal.
3	NOK acknowledgement per display	The NOK message must be acknowledged via the display.

Activating NOK buzzer



activate NOK buzzer and **sec. buzzer time** can be activated or deactivated via the "IO config" menu. If the entries are grayed out, the <switching point> function was assigned to the <Digital Out 4> output.

✓ The user is logged in with a suitable user level. The necessary write permissions are available.

1. Tap on **activate NOK buzzer** checkbox to activate beeper.
2. Tap on **buzzer time** input field.
 - ▷ The numerical keyboard opens.
3. Enter value in [s] and press the **OK** button to confirm.



If the value "0" is entered, the acoustic signal sounds until the NOK is acknowledged.

4. Tap on **Save** button to save the values.

Activate external NOK acknowledgement

✓ The user is logged in with a suitable user level. The necessary write permissions are available.

✓ **NOK acknowledgement per display** is not activated.

1. Tap on **external NOK acknowledgement** checkbox to activate external acknowledgement.
2. Tap on **Save** button to save the values.

Activating NOK acknowledgement per display

✓ The user is logged in with a suitable user level. The necessary write permissions are available.

✓ **external NOK acknowledgement** is not activated.

1. Tap on **NOK acknowledgement per display** checkbox to activate the acknowledgement per display.
2. Tap on **authorization level for acknowledgement** input field and select user level that can carry out the acknowledgement.
3. Tap on **Save** button to save the values.

Hardware

The following information is displayed in the "Hardware" menu

- Current process values in real time
- Digital inputs and outputs
- System time and date of the controller
- Serial number of the device hardware

System

The current measurement values of all connected sensors are displayed in the "Hardware \ System" menu.

In the "OUT" or "IN" columns, the active inputs and outputs (green) or deactivated inputs and outputs (red) are displayed.

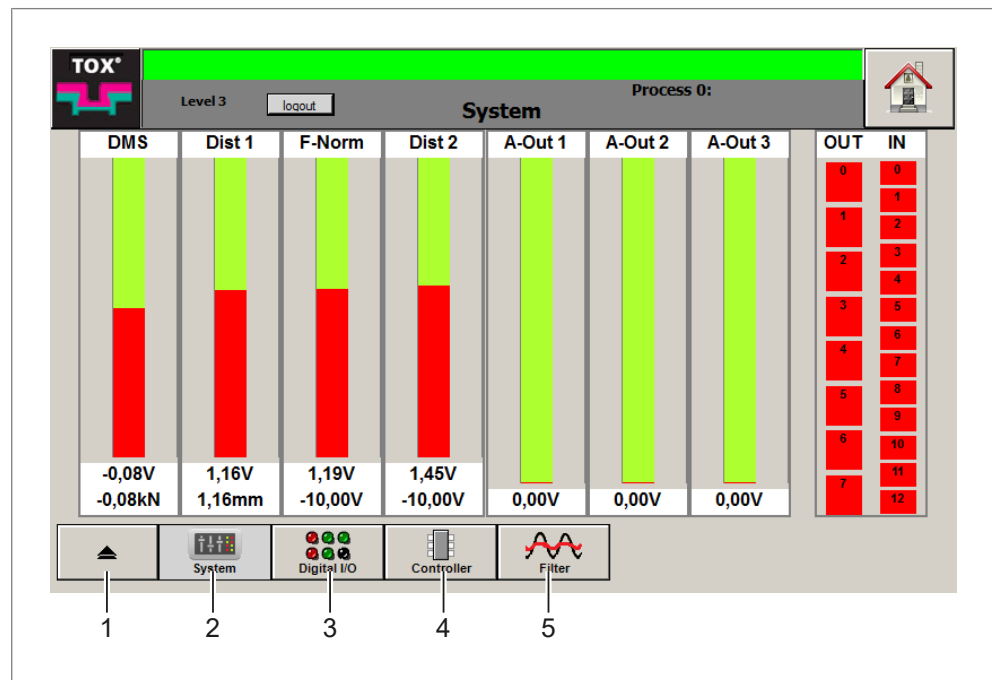

Fig. 36 "Hardware \ System" menu

	Button	Function
1		Changes to the higher menu
2	System	Opens System menu
3	Digital inputs/outputs	Opens digital inputs/outputs menu
4	Controller	Opens Controller menu
5	Filter	Opens Filter menu

Digital inputs/outputs

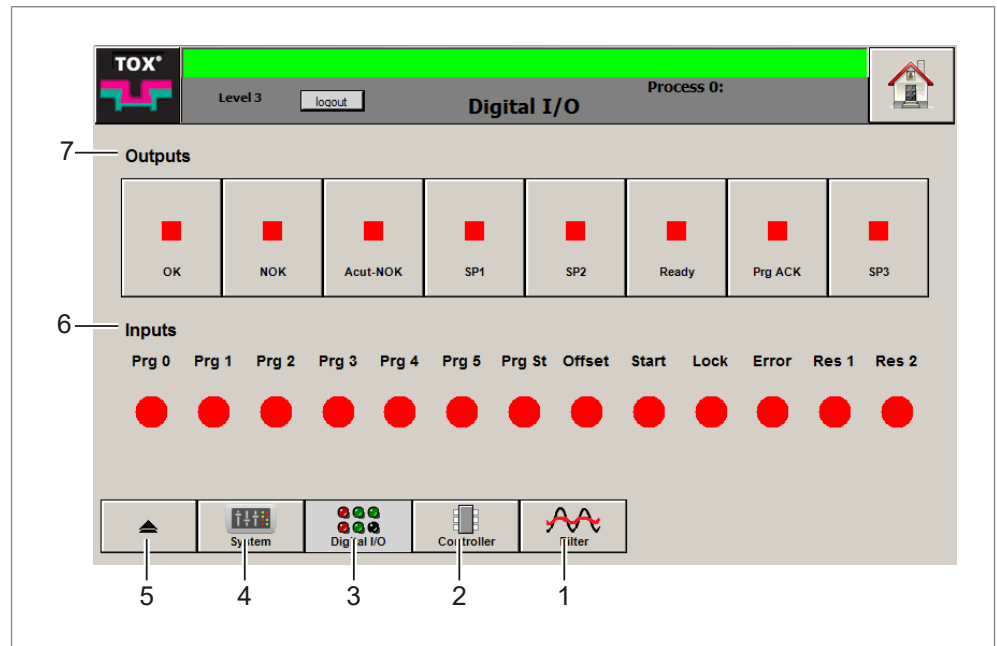

Fig. 37 "Hardware \ Digital inputs/outputs" menu

	Button	Function
1	Filter	Opens Filter menu
2	Controller	Opens Controller menu
3	Digital inputs/outputs	Opens digital inputs/outputs menu
4	System	Opens System menu
5		Changes to the higher menu

	Designation	Description
6	Inputs	The status of the digital inputs is displayed.
7	Outputs	The outputs are displayed, on which a signal is currently output.

The function of the occupied input and output is labeled in plain text.

- ✓ The user is logged in with a suitable user level. The necessary write permissions are available.
- ➔ Tap on the corresponding button of the output.
- ▶ The output is activated or deactivated.

Controller

The system time, date as well as serial number of the device hardware is displayed in the "Hardware \ Controller" menu.

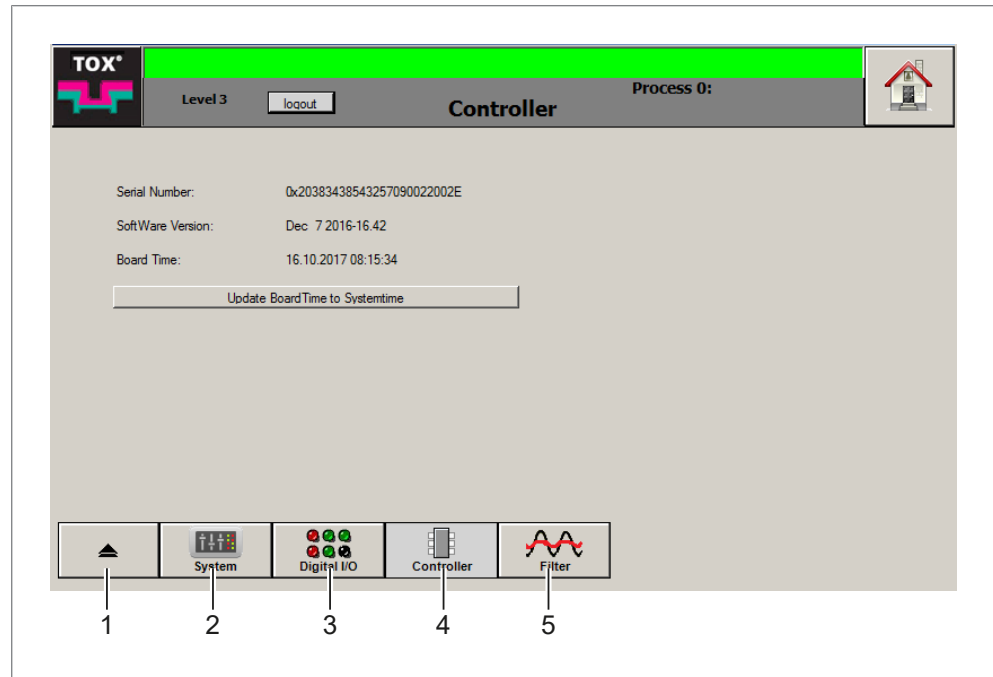

Fig. 38 "Hardware \ Controller" menu

	Button	Function
1		Changes to the higher menu
2	System	Opens System menu
3	Digital inputs/outputs	Opens digital inputs/outputs menu
4	Controller	Opens Controller menu
5	Filter	Opens Filter menu

Synchronizing the system time of the controller with the system time of the panel PC

- ✓ The user is logged in with a suitable user level. The necessary write permissions are available.
- ➔ Tap on **Update BoardTime to Systemtime** button.
- ▶ The system time is synchronized.

Filter

In the "Hardware \ Filter" menu, the signals can be smoothed for displaying the curves with less low-noise. The higher the respective value is, the lower the signal noise.

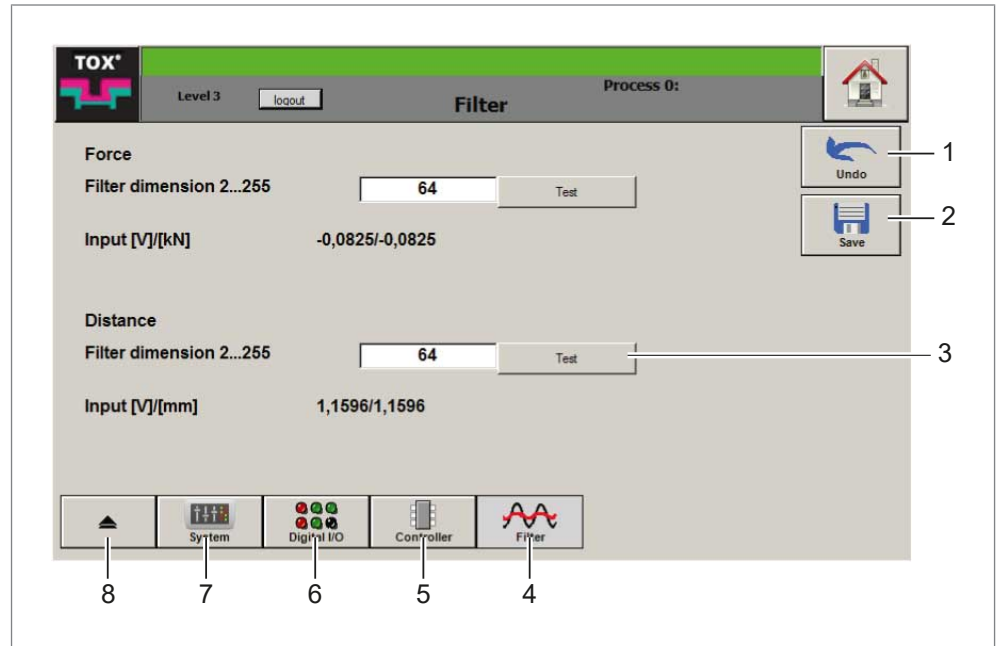

Fig. 39 "Hardware \ Filter" menu

	Button	Function
1	Undo	Undoes the entry
2	Save	Saves the entry
3	Test	to test the smoothing of the value
4	Filter	Opens Filter menu
5	Controller	Opens Controller menu
6	Digital inputs/outputs	Opens digital inputs/outputs menu
7	System	Opens System menu
8		Changes to the higher menu

- ✓ The user is logged in with a suitable user level. The necessary write permissions are available.
1. Tap on **Filter dimension** force or **Filter dimension** distance input field.
 - ▷ The numerical keyboard opens.
 2. Enter value and press the **OK** button to confirm.
 3. Tap on **Test** button to test the smoothing of the value.
 4. Tap on **Save** button to save the values.

9.4.5 Monitoring

Zoom

The user zoom is configured in the "Monitoring \ Zoom" menu.



Zooming is also possible via the "Home Screen" menu.

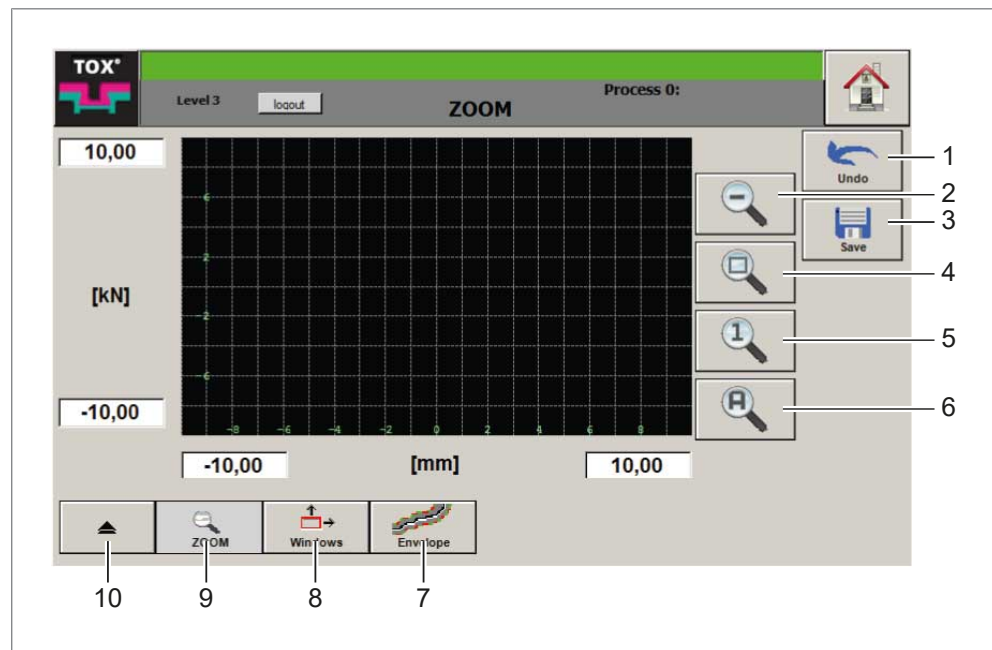

Fig. 40 "Monitoring \ Zoom" menu

	Button	Function
1	Undo	Undoes the entry
2		Reduces zoom factor
3	Save	Saves the entry
4	Zoom area	Displays the zoom area in the marked frame
5	Zoom factor	Sets the zoom factor to the value of the configuration for the nominal distance / nominal force
6		Autozoom
7	Envelope curve	Opens Envelope curve menu
8	Windows	Opens Windows menu
9	Zoom	Opens Zoom menu
10		Changes to the higher menu

The following configuration options are available:

- Change the zoom area graphically
- Change zoom area by direct entry of values

Change the zoom area graphically

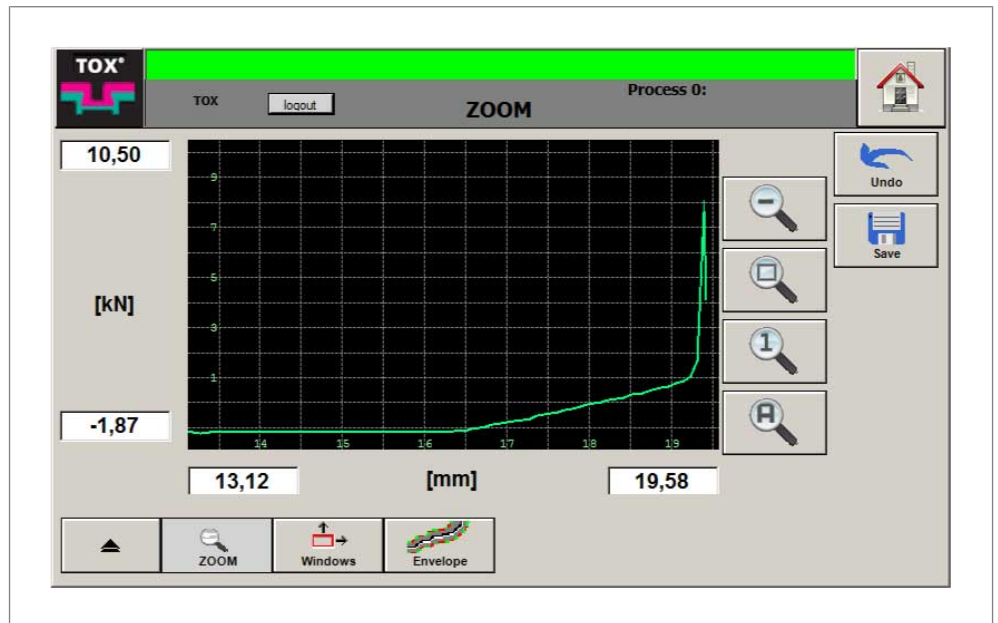

Fig. 41 "Monitoring \ Zoom" menu

Setting zoom area automatically

- ✓ The user is logged in with a suitable user level. The necessary write permissions are available.
- ➔ Tap on **Autozoom** button.

Increasing zoom area

- ✓ The user is logged in with a suitable user level. The necessary write permissions are available.
- ➔ Tap on **decrease zoom factor** button.
- OR -
Tap on any spot of the diagram.

Freely defining Zoom Area

- ✓ The user is logged in with a suitable user level. The necessary write permissions are available.

- 1. Tap on **zoom area in the marked frame** button.
- 2. Define the first point of the zoom frame by tapping on the diagram.
- 3. Define the second opposite point of the zoom frame by tapping again on the diagram.
 - ▷ The system zooms to the size of the resulting rectangle.
- 4. Tap on **Save** button to save the values.

Change zoom area by direct entry of values

In the "Monitoring \ Zoom" menu, the action window is adapted to the corresponding axes via the input fields (min/max).

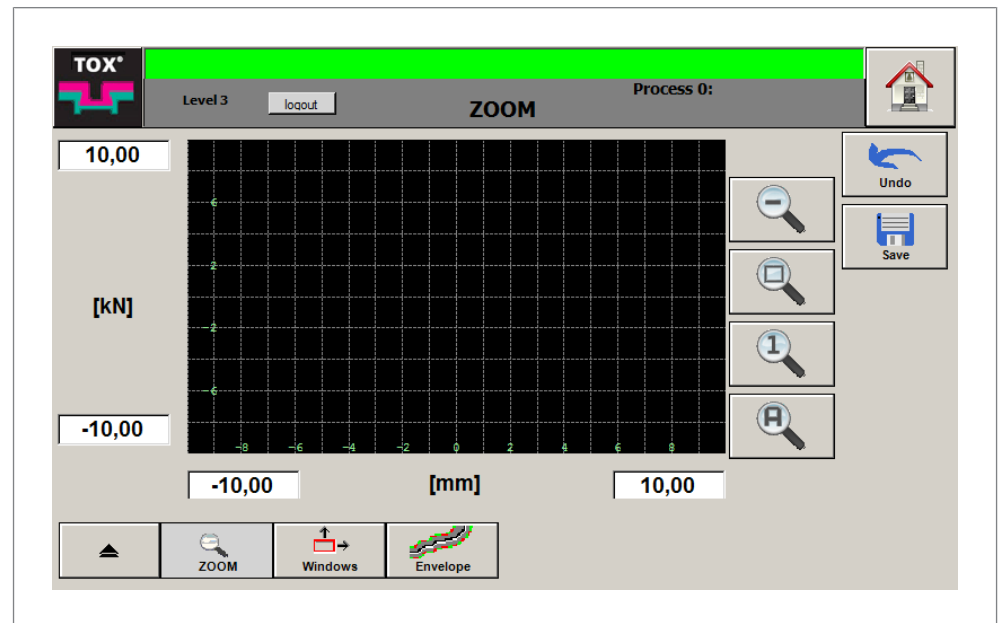

Fig. 42 "Enter zoom values" menu

- ✓ The user is logged in with a suitable user level. The necessary write permissions are available.
1. Tap on the value of the input field that has to be changed.
 - ▷ The numerical keyboard opens.
 2. Enter value in [mm] or [kN] and press the **OK** button to confirm.
 3. Change additional values accordingly.
 - ▷ The zoom area is adapted accordingly to the entered value.
 4. Tap on **Save** button to save the values.

Windows

In the "Monitoring \ Window" menu, evaluation windows can be created, changed or deleted.

The settings only apply for the current process.

Every window is identified by a number on the frame of the window.

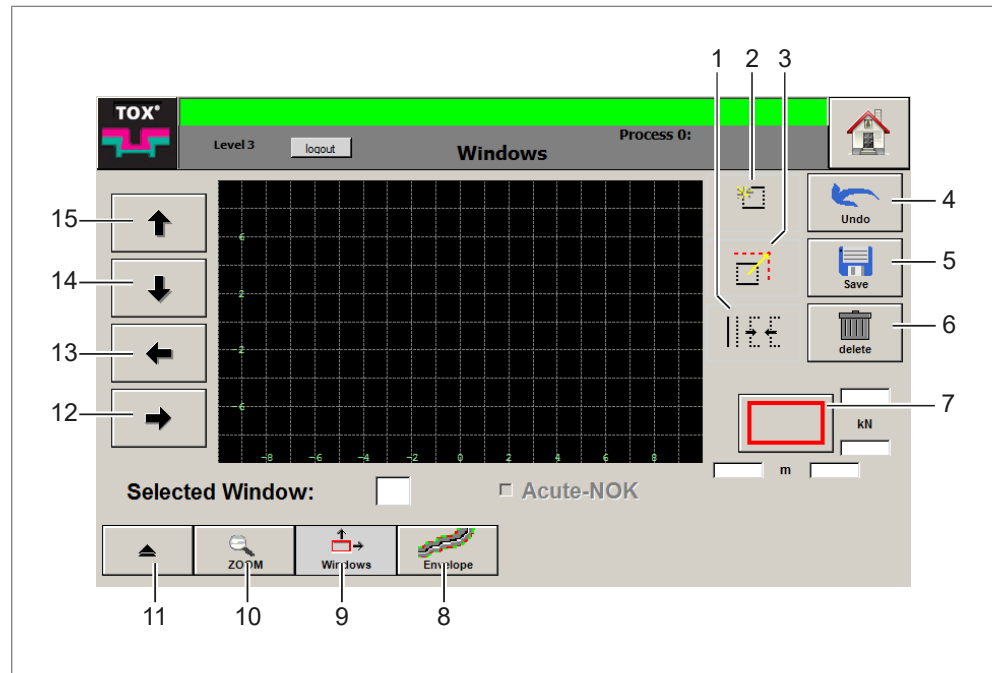

Fig. 43 "Monitoring \ Window" menu

	Button	Function
1	Window type	Edits window type
2	Windows	Creates a new window
3	Move	Moves the windows
4	Undo	Undoes the entry
5	Save	Saves the entry
6	Delete	Deletes the selected window
7	Window boundary	Selects window edge Four text fields show the dimensions of the selected window.
8	Envelope curve	Opens Envelope curve menu
9	Windows	Opens Windows menu
10	Zoom	Opens Zoom menu
11		Changes to the higher menu
12	Right	Moves window or window side to the right
13	Left	Moves window or window side to the left
14	Bottom	Moves window or window side to the bottom
15	Top	Moves window or window side to the top

Creating window

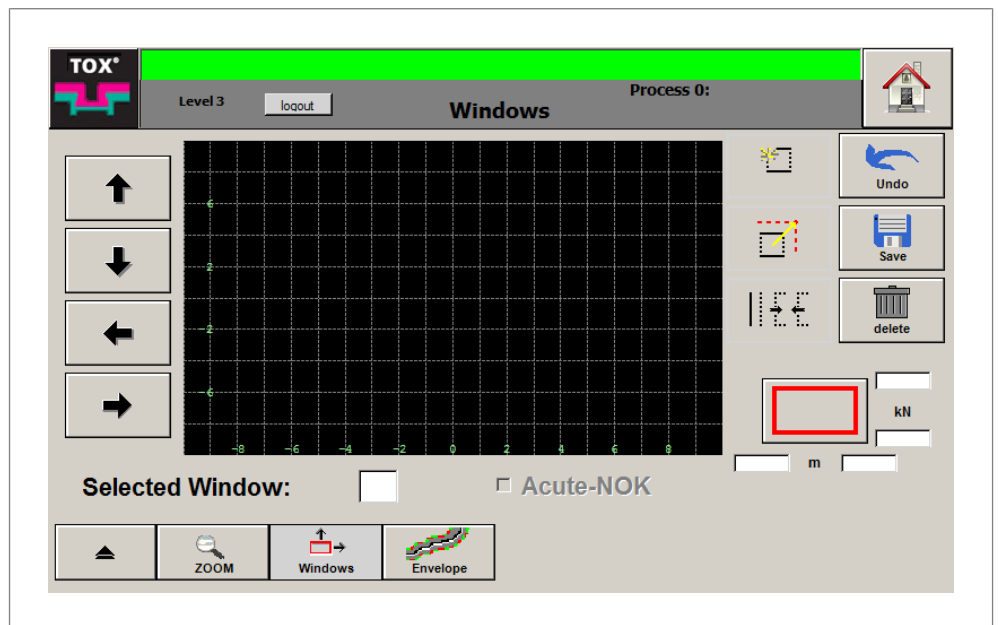

Fig. 44 "Create Monitoring \ Window " menu

- ✓ The user is logged in with a suitable user level. The necessary write permissions are available.
1. Tap on screen at the point where the window should start.
 - ▷ A red cross hair appears.
 2. Tap on screen at the opposite point where the window should end.
 - ▷ A second red cross-hair appears.
 3. If the window does not fit: Delete the window by tapping on any point on the screen and define a new window again (steps 1 and 2).
 4. Tap on **Create window** button to create the window.
 - ▷ The new window is outlined with a green border.
 - ▷ The number of the window is displayed at the bottom left of the frame.
 5. Tap on **Save** button to save the values.

Selecting Window

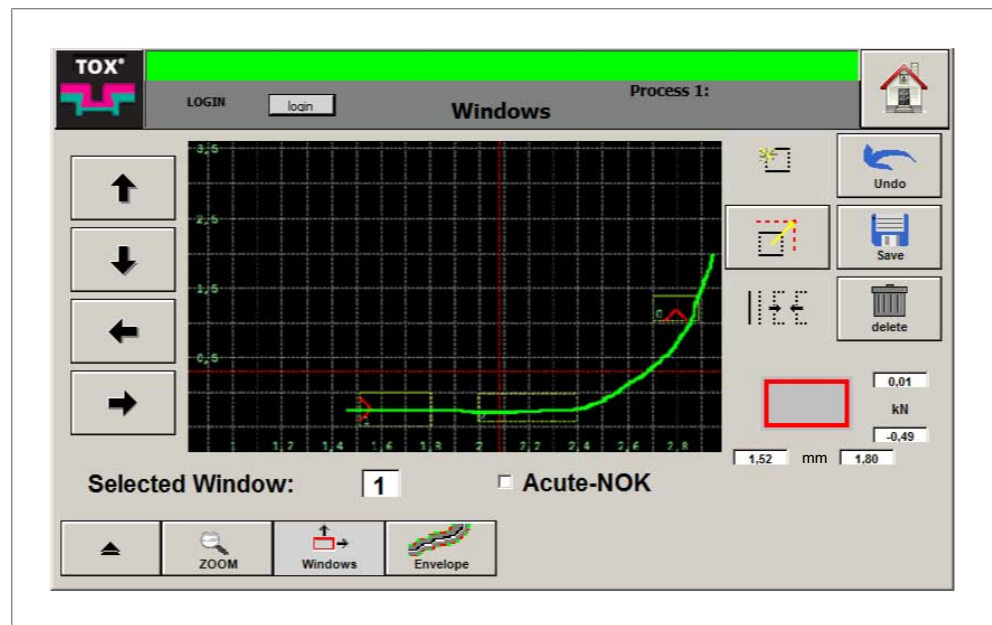

Fig. 45 "Monitoring \ Window" menu

Only one window can ever be selected. The number of the selected window is displayed in the **selected window** input field.

✓ The user is logged in with a suitable user level. The necessary write permissions are available.

→ Tap the window directly on the screen.

– OR –

1. Tap on **Selected window** input field.

▷ The numerical keyboard opens.

2. Enter window number and press the **OK** button to confirm.

Moving window

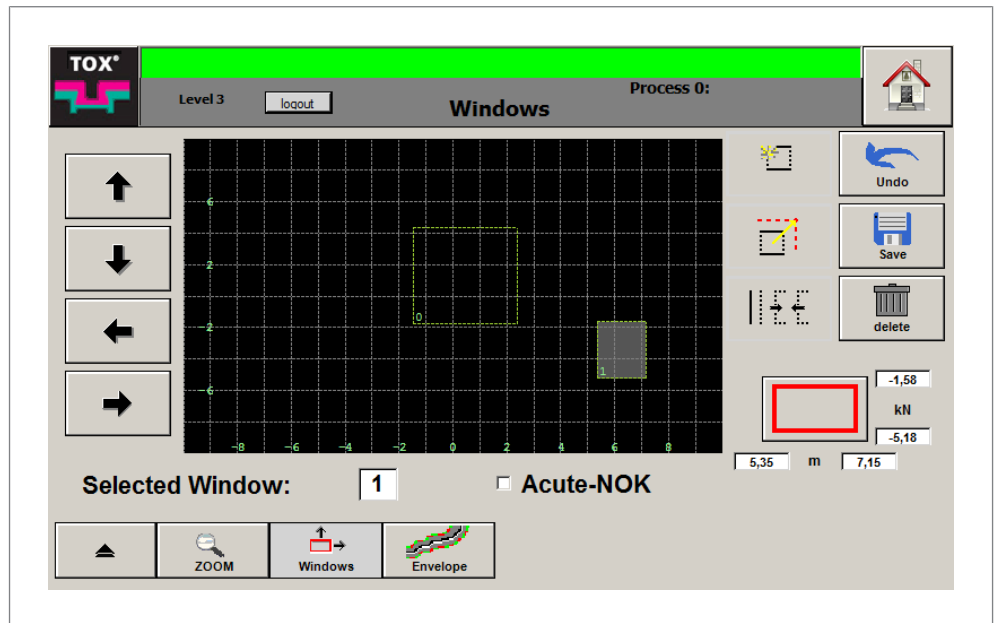

Fig. 46 "Monitoring \ Window" menu

Move by tapping on the screen

- ✓ The user is logged in with a suitable user level. The necessary write permissions are available.
 - ✓ The desired window is selected.
See [Selecting Window, Page 86](#).
1. Tap coordinate on the screen, on which the selected window should be centered.
 - ▷ A red cross hair appears.
 2. Tap on **Move window** button.
 - ▷ The selected window is centered on the red cross-hair.
 3. Tap on **Save** button to save the values.

Moving with arrow keys

- ✓ The user is logged in with a suitable user level. The necessary write permissions are available.
 - ✓ The desired window is selected.
See [Selecting Window, Page 86](#).
1. Move selected window using the arrow keys.
 2. Tap on **Save** button to save the values.

Changing the size of the window

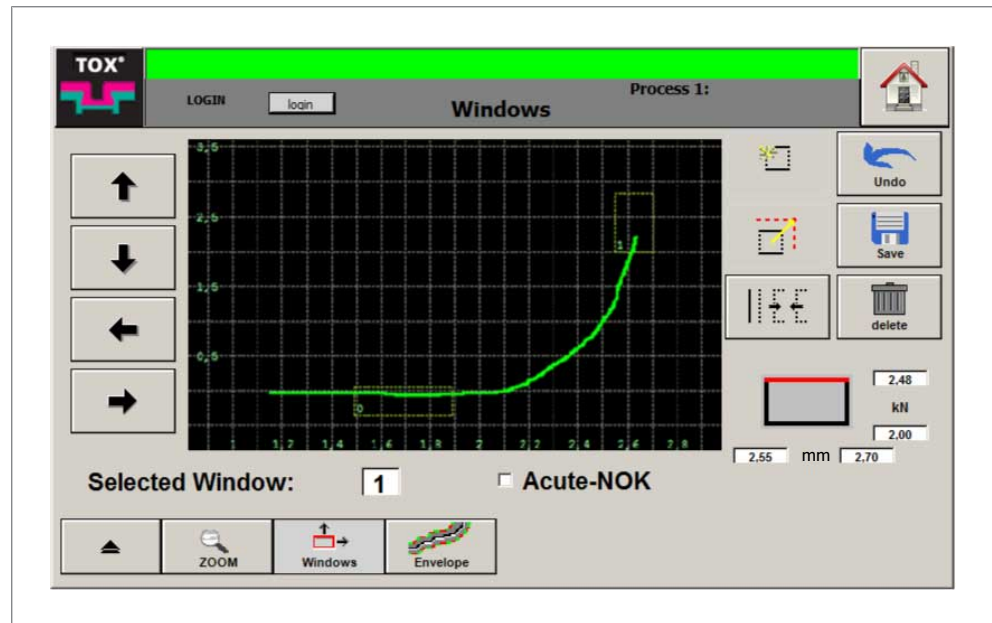

Fig. 47 "Monitoring \ Window" menu

Changing size of Window using Arrow Keys

- ✓ The user is logged in with a suitable user level. The necessary write permissions are available.
 - ✓ The desired window is selected.
See [Selecting Window, Page 86](#).
1. Tap on **Window boundary** repeatedly until the size of the window to be changed is highlighted in red on the button.
 2. Move the window side with the corresponding arrow key.
 3. Tap on **Save** button to save the values.

Changing Size of Window by entering a Value

- ✓ The user is logged in with a suitable user level. The necessary write permissions are available.
 - ✓ The desired window is selected.
See [Selecting Window, Page 86](#).
1. Tap on the input field of the window that is to be changed.
 2. Enter values and press the **OK** button to confirm.
 3. Tap on **Save** button to save the values.

Changing Window Condition

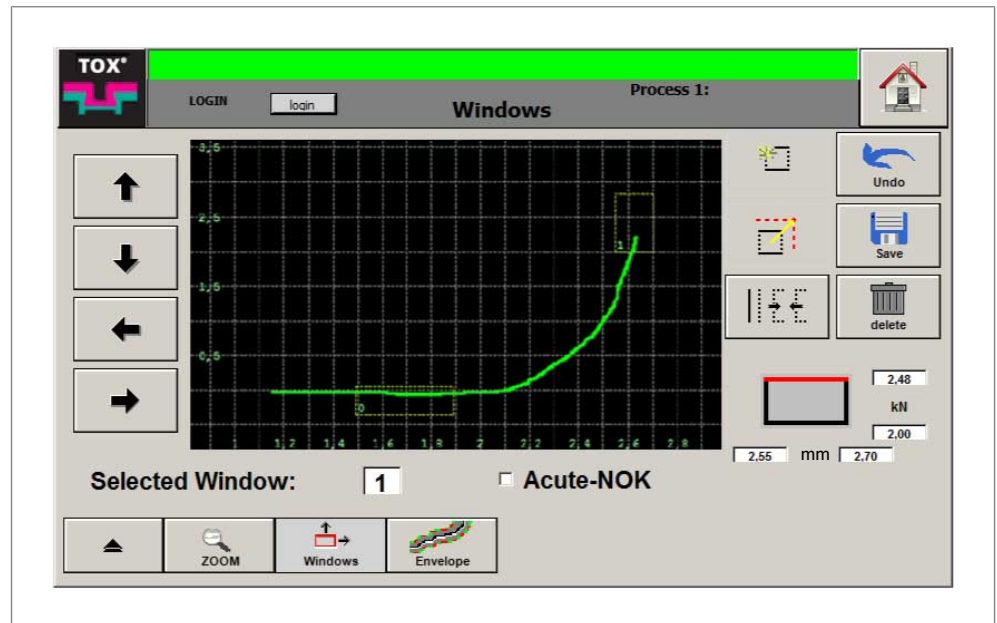

Fig. 48 "Monitoring \ Window" menu

The measuring curve must enter at the specified entry side of the window and exit at the specified exit side.

Entry side and exit side are freely definable. The first point of intersection of the curve with a window boundary is the entry event, the subsequent point of intersection with a window boundary is the exit event.

Examples:

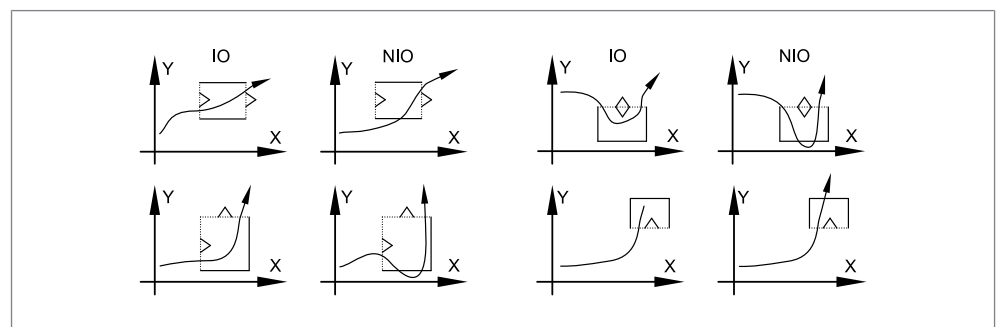
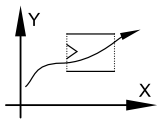
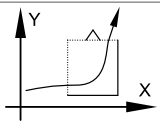
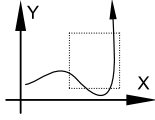
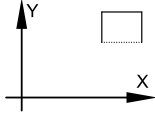

Fig. 49 Examples of window boundaries

Windows	Mode
	Curve entry
	Curve exit

Windows	Mode
	Curve entry or exit as desired
	No curve entry or exit

Tab. 2 Modes for window boundaries

- ✓ The user is logged in with a suitable user level. The necessary write permissions are available.
 - ✓ The desired window is selected.
See [Selecting Window, Page 86](#).
1. Tap on **Window boundary** repeatedly until the size of the window to be changed is highlighted in red on the button.
 2. Tap on **Modes** button repeatedly until the desired mode is displayed.
 3. Tap on **Save** button to save the values.

Delete window

Windows that are no longer needed or which were created incorrectly can be deleted.

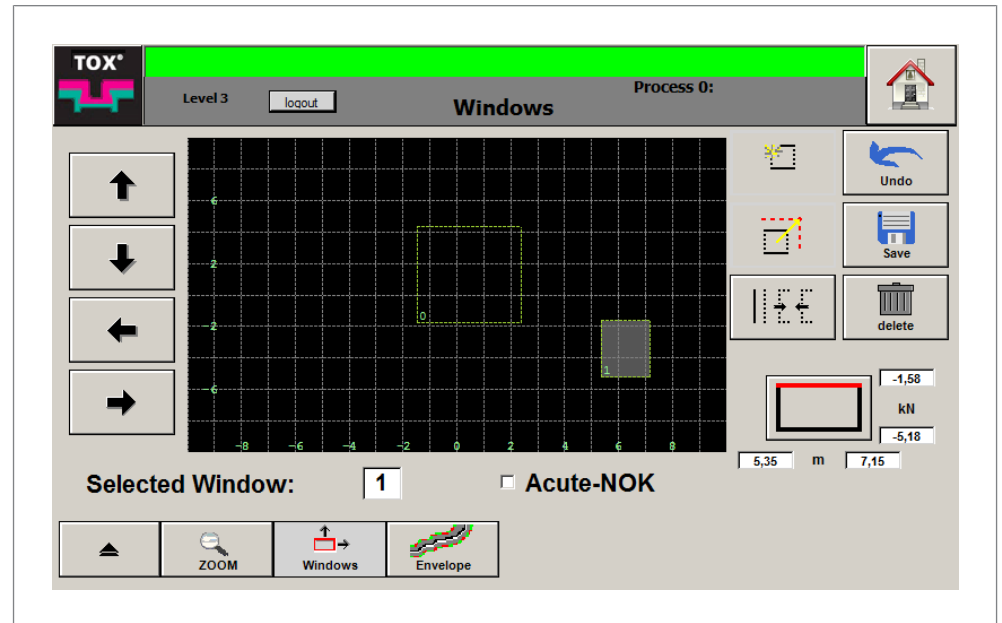

Fig. 50 "Monitoring \ Window" menu

- ✓ The user is logged in with a suitable user level. The necessary write permissions are available.
 - ✓ The window which is to be moved is selected.
See [Selecting Window, Page 86](#).
1. Tap on **Delete** button.
 - ▷ The selected window is deleted.
 2. Tap on **Save** button to save the values.

Acute NOK

By activating the **Acute NOK** option, the <Acute NOK> output is set if the window is violated.

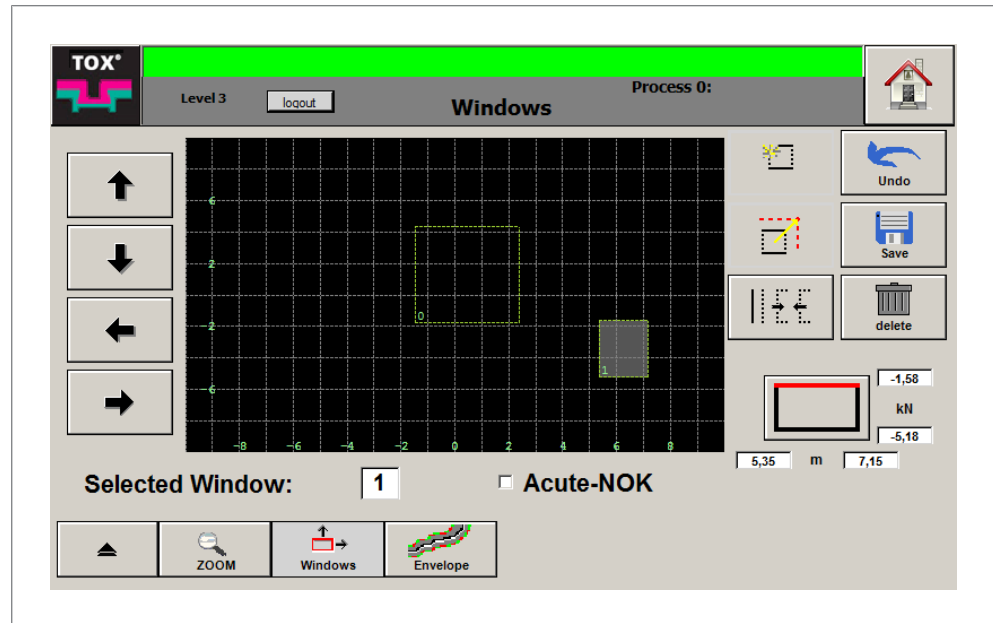

Fig. 51 "Monitoring \ Window" menu

- ✓ The user is logged in with a suitable user level. The necessary write permissions are available.
- ✓ The desired window is selected.
See [Selecting Window, Page 86](#).

1. Activate option by tapping on the checkbox.
2. Tap on **Save** button to save the values.

Envelope curve

In the "Monitoring \ Envelope curve" menu, the envelope curve can be configured.

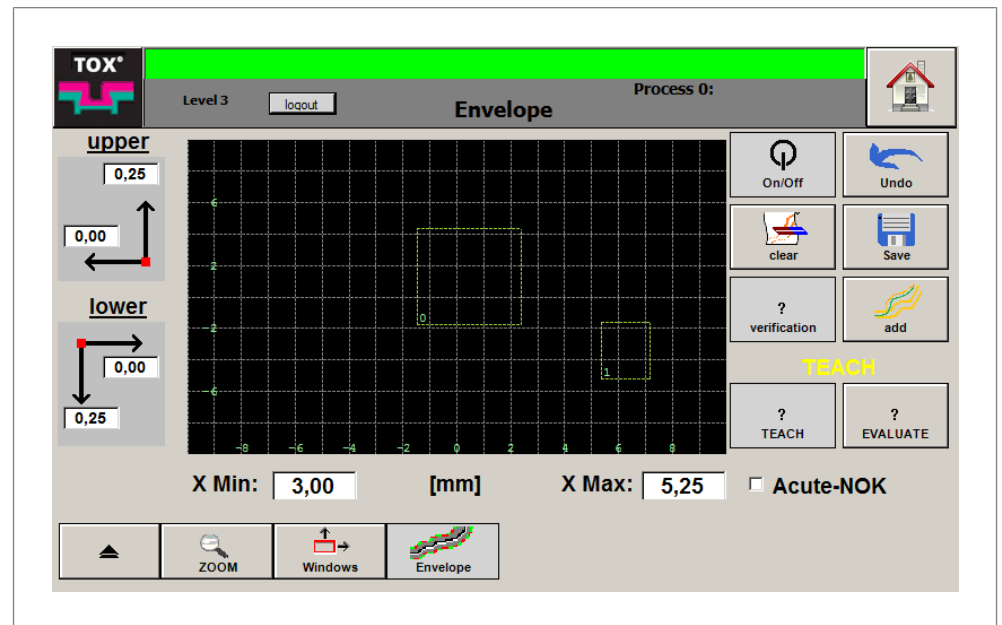

Fig. 52 "Monitoring \ Envelope curve" menu

The envelope curve is used wherever fast teaching-in of evaluation elements is required.

The measuring curve must run through the envelope curve and not violate the boundary lines in the process

Switching envelope curve edit mode on/off

- ✓ The user is logged in with a suitable user level. The necessary write permissions are available.
- ➔ Tap on **On/Off** button to switch the function on or off.

Teaching-in/Activating Envelope Curve

In the <Teach-in> mode, the measured curves are recorded and the enveloping boundaries (top/bottom envelope curve) are formed.

- ✓ The user is logged in with a suitable user level. The necessary write permissions are available.
 - ✓ Edit mode is switched on.
See [Switching envelope curve edit mode on/off, Page 93](#).
1. Tap on **Teach-in** button.
 2. Execute work process at least 15 times.
 - ▷ Several curves are recorded.
 3. Tap on **X Min** input field to define entry coordinates of the curve.
 - ▷ The numerical keyboard opens.
 4. Enter value in [mm].
 5. Press the **OK** button to confirm.
 6. Tap on **X Max** input field to define exit coordinates of the curve.
 - ▷ The numerical keyboard opens.
 7. Enter value in [mm].
 8. Press the **OK** button to confirm.
 9. Enter shift of the top boundary via the **top** input field. The boundary line is thereby shifted accordingly.
 10. Enter shift of the bottom boundary via the **bottom** input field. The boundary line is thereby shifted accordingly.
 11. Tap on **Save** button to save the values.
 12. Tap on the **Evaluate** button to exit teaching-in and to switch to the <Evaluate> mode.
 - ▶ The envelope curve is now monitored actively.

<Confirmation> Option

- ✓ The user is logged in with a suitable user level. The necessary write permissions are available.
 - ✓ Edit mode is switched on.
See [Switching envelope curve edit mode on/off, Page 93](#).
 - ✓ Teach-in mode is activated.
1. Tap on **Confirmation** button.
 - ▷ Recorded curve is used for teaching-in.
 2. Tap on **add** button.
 - ▷ Recorded curve is added for teaching-in.

Deleting Envelope Curve

- ✓ The user is logged in with a suitable user level. The necessary write permissions are available.
 - ✓ Edit mode is switched on.
See [Switching envelope curve edit mode on/off, Page 93](#).
1. Tap on **Delete** button to delete the envelope curve.
 2. Tap on **Save** button to save the values.

Supplementing Envelope Curve

- ✓ The user is logged in with a suitable user level. The necessary write permissions are available.
 - ✓ Edit mode is switched on.
See [Switching envelope curve edit mode on/off, Page 93](#).
1. Tap on **Evaluate** button.
 2. Tap on **add** button.
 - ▷ The envelope curve is supplemented by a recorded curve outside the boundary.

9.4.6 Counters

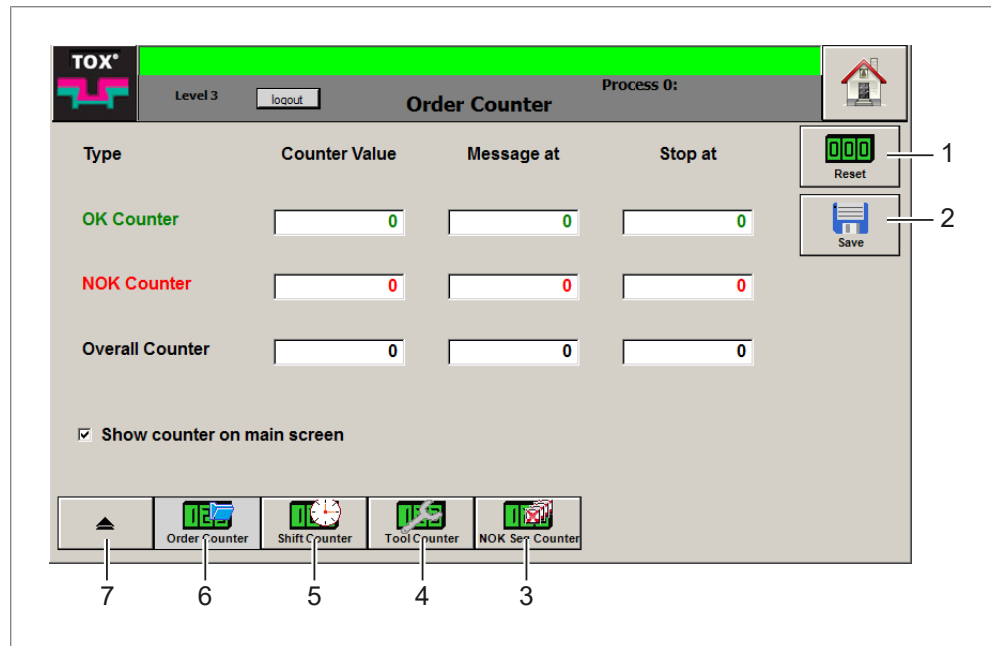

Fig. 53 Menu "Counter"

	Button	Function
1	Reset	Resets the counter
2	Save	Saves the entry
3	NOK seq counter	Opens NOK seq counter menu
4	Tool counter	Opens tool counter menu
5	Shift counter	Opens Shift counter menu
6	Job counter	Opens Job counter menu
7		Changes to the higher menu

All counters contain the following values:

- Good parts: Value increases after each measurement completed with OK.
- Bad parts: Value increases after each measurement completed with NOK.
- Total parts: Value increases after each measurement and is the total of good parts and bad parts.

Job Counter/Shift Counter

In the "Counter \ Job counter" or "Shift counter" menu, the respective counter states are displayed for the current job or current shift.

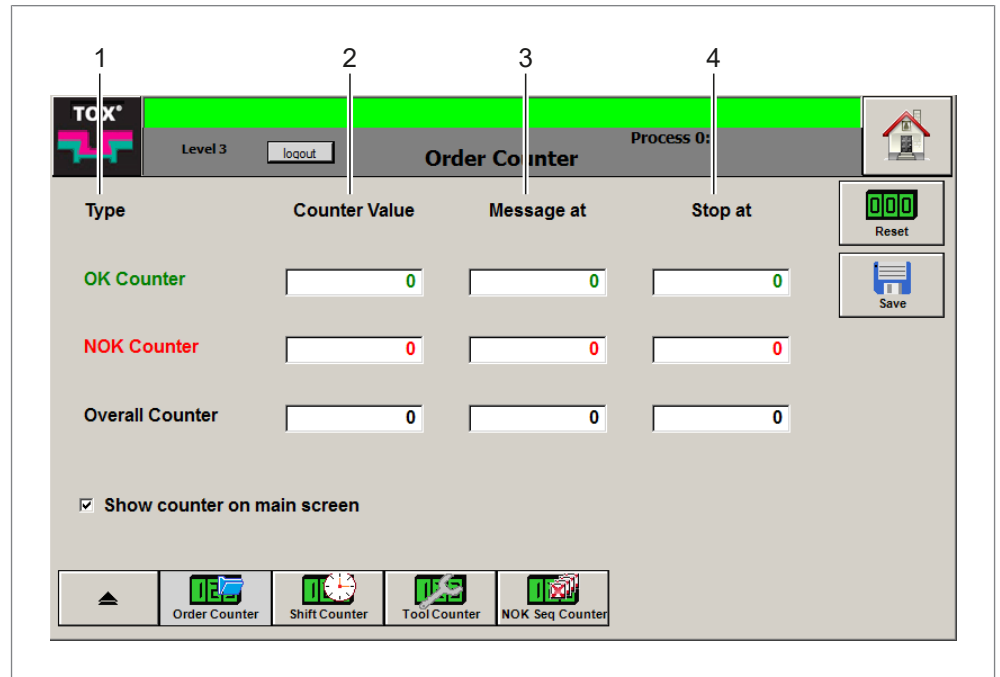

Fig. 54 "Counter \ Job counter" menu

	Field	Meaning
1	Type	Part type
2	Counter value	Current value of the respective part type
3	Message at	Number of parts at which a message is generated.
4	Stop at	Number of parts at which the system shuts down.

Tool counter

In the "Counter \ Tool counter" menu, the counter value is displayed for the current tool.

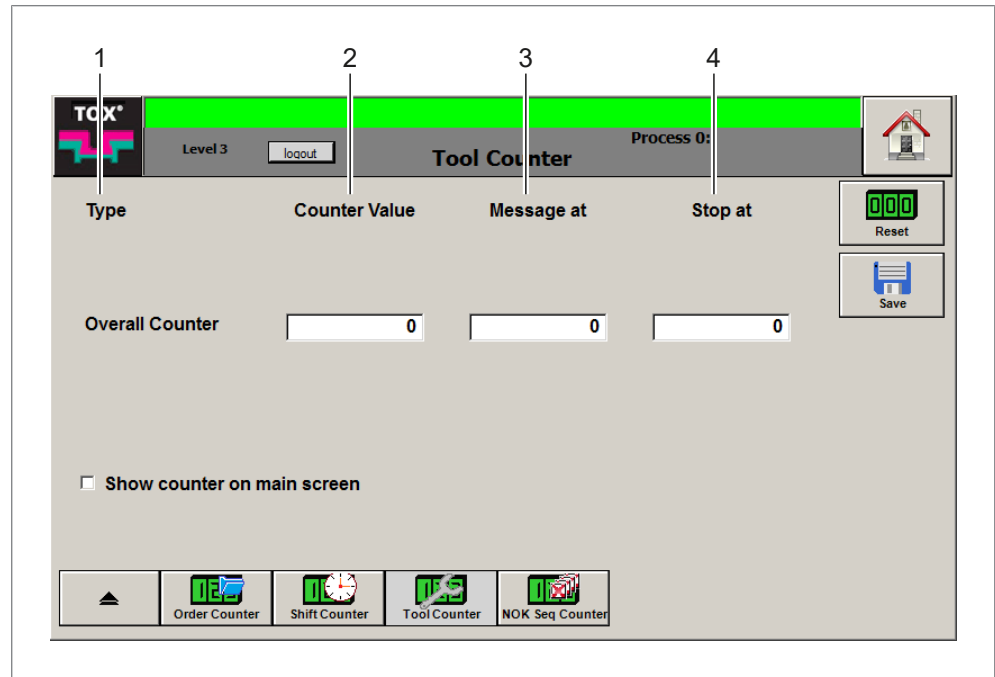

Fig. 55 "Counter \ Tool counter" menu

	Field	Meaning
1	Type	Part type
2	Counter value	Current value of the respective part type
3	Message at	Number of parts until a message is generated.
4	Stop at	Number of parts when the system shuts down.

NOK seq counter

In the "Counter \ NOK seq counter" menu, the NOK components produced in succession are counted.

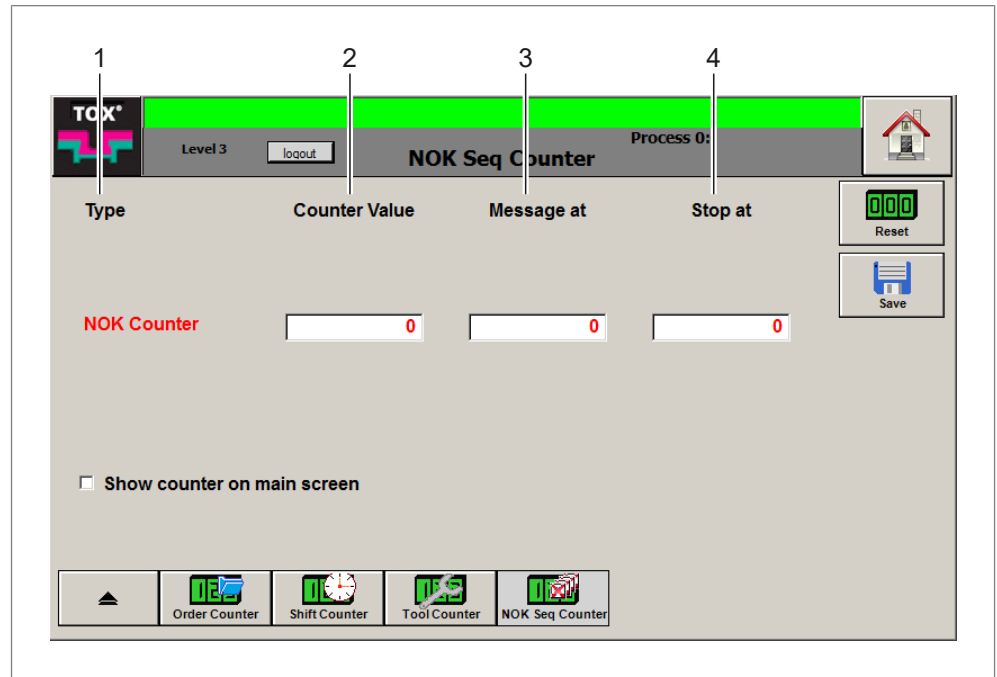

Fig. 56 "Counter \ NOK seq counter" menu

	Field	Meaning
1	Type	Part type
2	Counter value	Current value of the respective part type
3	Message at	Number of parts until a message is generated.
4	Stop at	Number of parts when the system shuts down.

Setting Message

A value can be entered for each part type via the **Message at** input field. Once the counter value reaches the value, a message is issued.

The value <0> deactivates the option and no message is issued.

- ✓ The user is logged in with a suitable user level. The necessary write permissions are available.

1. Tap on **Message at** input field of the corresponding part type.
2. Enter trigger value and press the **OK** button to confirm.
3. Tap on **Save** button to save the values.

Setting Stop

A value can be entered for each part type via the **Stop at** input field. Once the counter value reaches the value, the system shuts down and a corresponding message is issued.

As soon as the counter value is reached, the <ready to measure> signal for the following measurement is not set. A counter value message (with a red background) is issued.

Tapping on the **Reset** button resets the counter. After that, the next measurement can be continued.

The value <0> deactivates the corresponding option. The system is not shut down and no message is issued.

- ✓ The user is logged in with a suitable user level. The necessary write permissions are available.
1. Tap on **Stop at** input field of the corresponding part type.
 2. Enter trigger value and press the **OK** button to confirm.
 3. Tap on **Save** button to save the values.

Reset counter limit

- ✓ The user is logged in with a suitable user level. The necessary write permissions are available.
- Tap on **Reset** button.
- ▶ The counter values are reset.

Displaying Counter in Main Screen

The corresponding counter can be displayed in the "Channel cockpit" menu via the option **Display counter in main screen**.

- ✓ The user is logged in with a suitable user level. The necessary write permissions are available.
1. Tap on **Display counter in main screen** input field.
 - ▷ The counter is displayed in the main screen.
 2. Tap on **Save** button to save the values.

9.4.7 Processes

A process can either be selected by an external PLC or in the "Processes" menu.

Processes

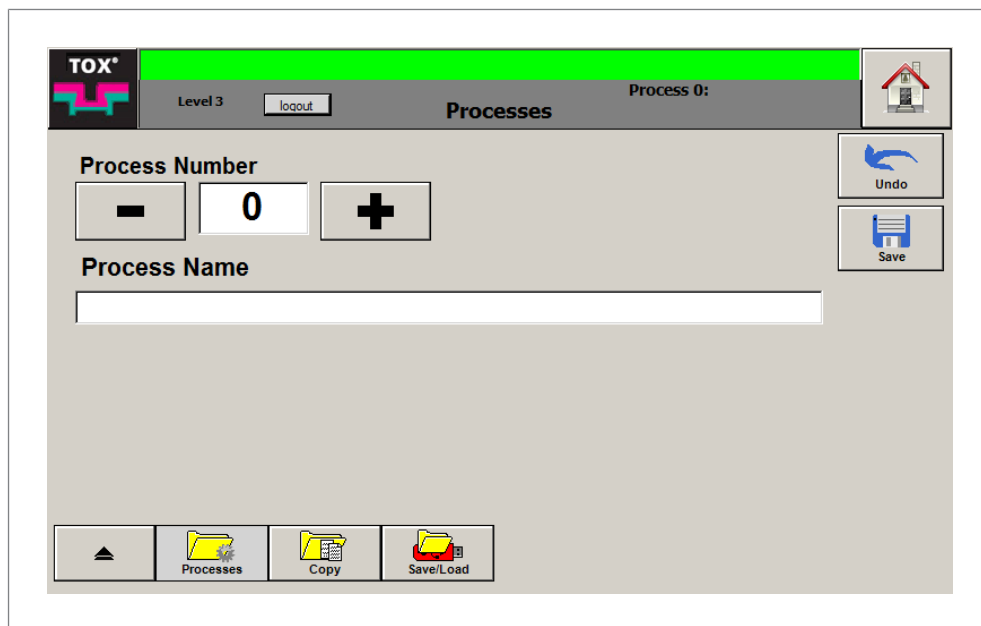

Fig. 57 "Processes \ Processes" menu

Selecting Processes

Selection by entering a Value

- ✓ The user is logged in with a suitable user level. The necessary write permissions are available.
1. Tap on **process number** input field.
 - ▷ The numerical keyboard opens.
 2. Enter process number and press the **OK** button to confirm.
 3. Tap on **Save** button to save the values.

Selection by Function Buttons

- ✓ The user is logged in with a suitable user level. The necessary write permissions are available.
1. Select process by tapping the <-> or <+> buttons.
 2. Tap on **Save** button to save the values.

Assigning Process Name

A name can be assigned for each process.

- ✓ The user is logged in with a suitable user level. The necessary write permissions are available.
1. Select process.
 2. Tap on **process name** input field.
 - ▷ The alphanumeric keyboard opens.
 3. Enter process name and press the **OK** button to confirm.
 4. Tap on **Save** button to save the values.

Copy

In the "Process \ Copy" menu, process parameters can be copied from a source process to several target processes.

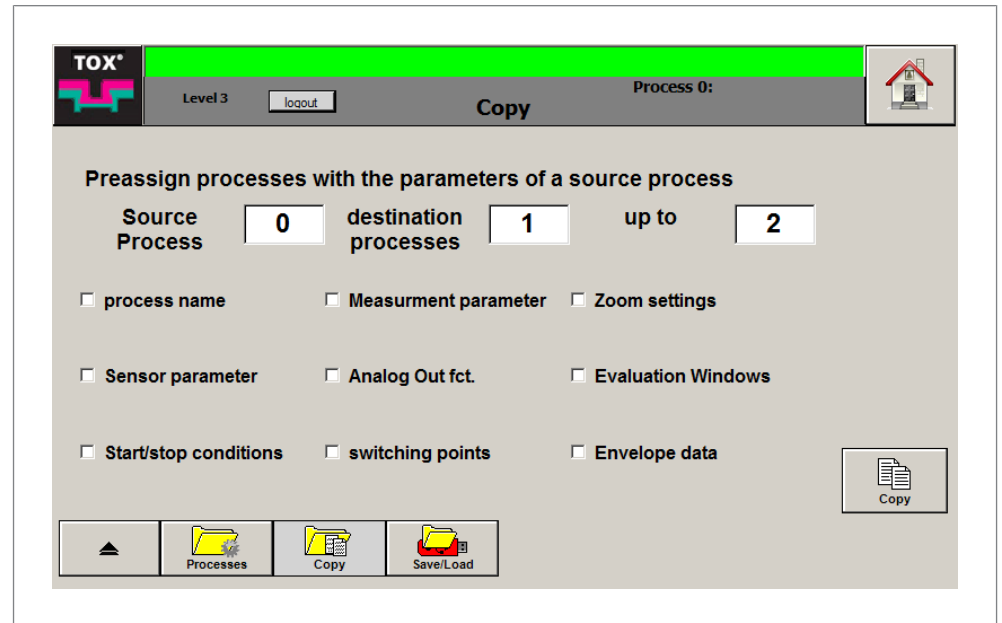

Fig. 58 Menu "Process \ Copy"

- ✓ The user is logged in with a suitable user level. The necessary write permissions are available.
1. Tap on **source process** input field.
 - ▷ The numerical keyboard opens.
 2. Enter source process number and press the **OK** button to confirm.
 3. Tap on **target process** input field.
 - ▷ The numerical keyboard opens.
 4. Enter process number of the first target process.
 5. Tap on **target processes to** input field.
 - ▷ The numerical keyboard opens.
 6. Enter the process number of the last target process.
 7. Select the process parameters to be copied by tapping on the checkbox.
 8. **NOTE!** Data loss! The old process settings in the target process are overwritten by copying.
Start copying process by tapping on the **Copy** button.

Example

The data from source process <0> are to be copied to the target processes <1> to <2>.

1. Enter the process number <0> in **source process** input field.
2. Enter the process number <1> in **target process** input field.
3. Enter the process number <2> in **target processes to** input field.
4. Select the process data to be copied.
5. Start copying process by tapping on the **Copy** button.

Saving/Loading

In the "Processes \ Save/Load" menu, process parameters can be saved on or loaded from an external data carrier (e.g. USB stick).

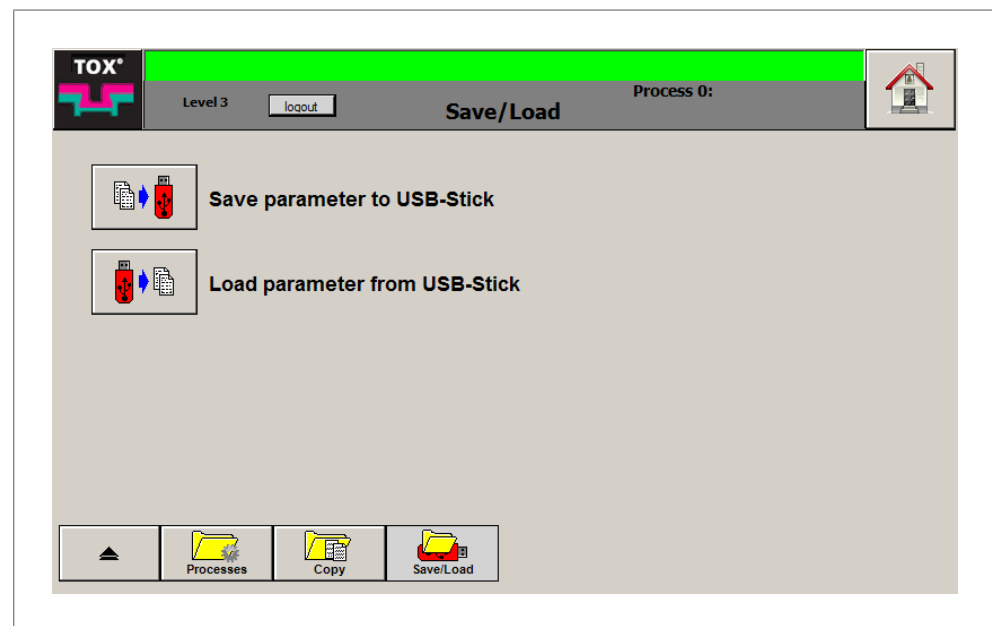

Fig. 59 Menu "Processes \ Save/Load"

Copying Process Parameters

- ✓ The user is logged in with a suitable user level. The necessary write permissions are available.
- ✓ An external data medium is connected.
- ➔ Tap on **Save parameters to USB stick** button.
- ▶ All parameters and processes are saved on the connected data carrier.

Loading Process Parameters

- ✓ The user is logged in with a suitable user level. The necessary write permissions are available.
- ✓ An external data carrier is connected

NOTE

Data loss!

When the data of the data carrier is loaded to the TOX®-pressing monitor, all processes and parameters are overwritten.

1. Tap on **Load parameters from USB stick** button.
2. Select dataset to be loaded and press the **OK** button to confirm.

9.4.8 System

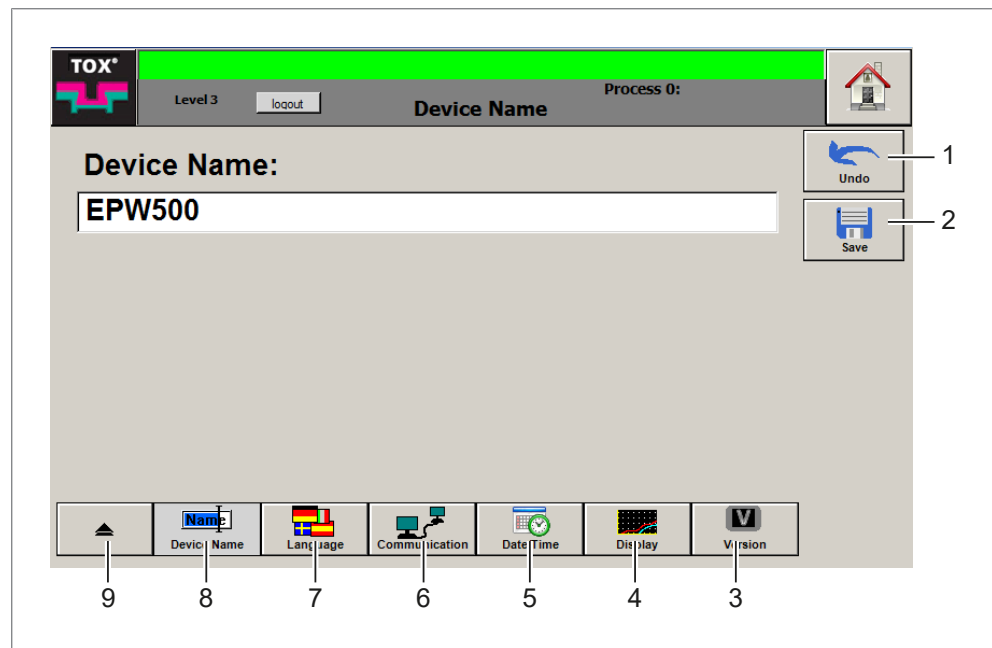

Fig. 60 "System \ Addition" menu

	Button	Function
1	Undo	Undoes the entry
2	Save	Saves the entry
3	Version	Opens Version menu
4	Display	Opens Displaymenu
5	Date/Time	Opens Date/Time menu
6	Communication	Opens Communication menu
7	Language	Opens Language menu
8	Device name	Opens Device name menu
9		Changes to the higher menu

Assigning Device Name

If several pressing monitors are used, it is recommendable to assign a unique name for each device. If data is saved on a USB stick, this device name is used in the file name. This enables the imported data to be uniquely assigned.

- ✓ The user is logged in with a suitable user level. The necessary write permissions are available.
- 1. Tap on **Device name** input field.
 - ▷ The alphanumeric keyboard opens.
- 2. Enter device name and press the **OK** button to confirm.
- 3. Tap on **Save** button to save the values.

Changing Language



Fig. 61 "System \ Language" menu

In the "System \ Language" menu, you have the option to change the user interface language.

- ✓ The user is logged in with a suitable user level. The necessary write permissions are available.
- ➔ Tap on the desired language to select it.
- ▶ The selected language will be available immediately

Configuring Communication

In the "communication" menu, the Ethernet IP address can be configured.

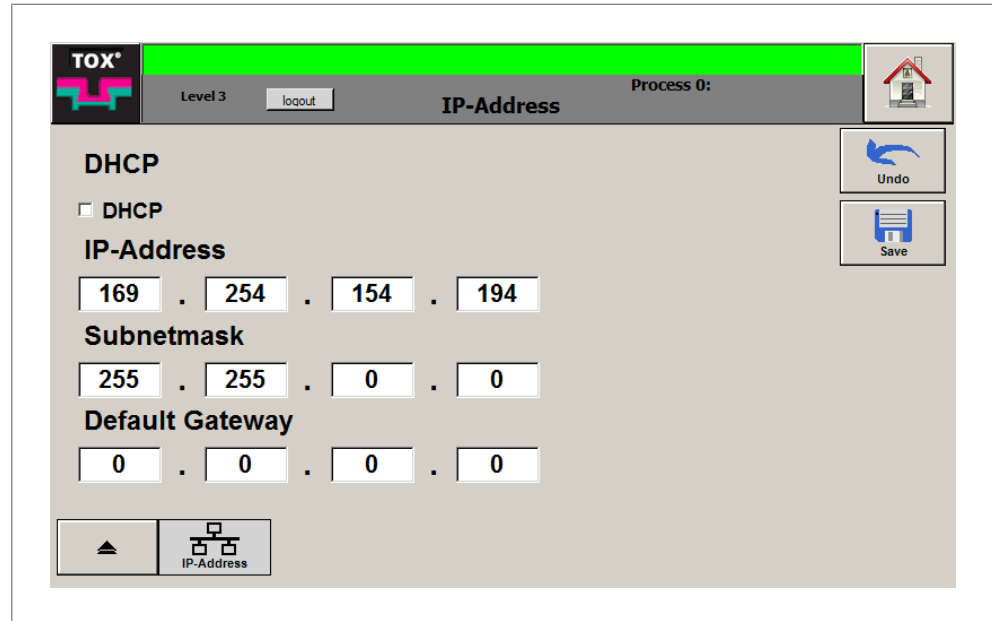

Fig. 62 "system \ communication \ IP address" menu

Defining IP address via the DHCP protocol

- ✓ The user is logged in with a suitable user level. The necessary write permissions are available.

→ Tap on **DHCP** checkbox.

Defining IP Address by entering a Value

- ✓ The user is logged in with a suitable user level. The necessary write permissions are available.
1. Tap on the first input field of the **IP address** group, enter the first three digits of the IP address to be used and press the **OK** button to confirm.
 - ▷ The numerical keyboard opens.
 2. Repeat the procedure for all input fields in the **IP address** group.
 3. Repeat point 2 and 3 to enter the **Subnet mask** and **Default Gateway**.
 4. Tap on **Save** button to save the values.

Setting Date/Time

In the "System \ Date/Time" menu, the device time and device date can be configured.

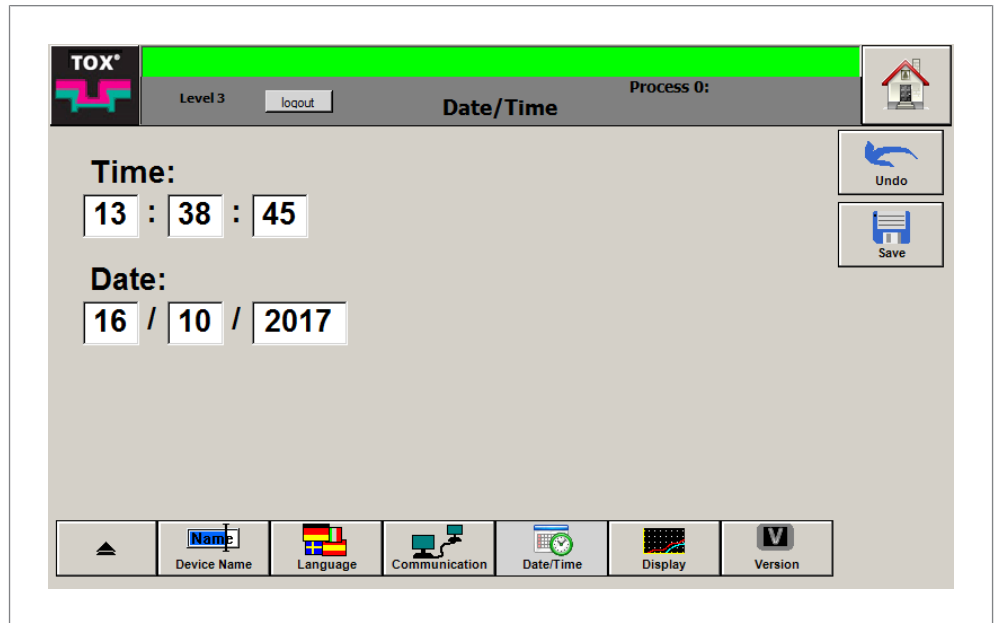

Fig. 63 "System \ Date/Time" menu

- ✓ The user is logged in with a suitable user level. The necessary write permissions are available.
- 1. Tap on the **Time** or **Date** input fields.
 - ▷ The numerical keyboard opens.
- 2. Enter values in the corresponding fields and press the **OK** button to confirm.
- 3. Tap on **Save** button to save the values.

Configuring Display

In the "System \ Display" menu, the settings for the display in the "Channel Cockpit" menu are performed.

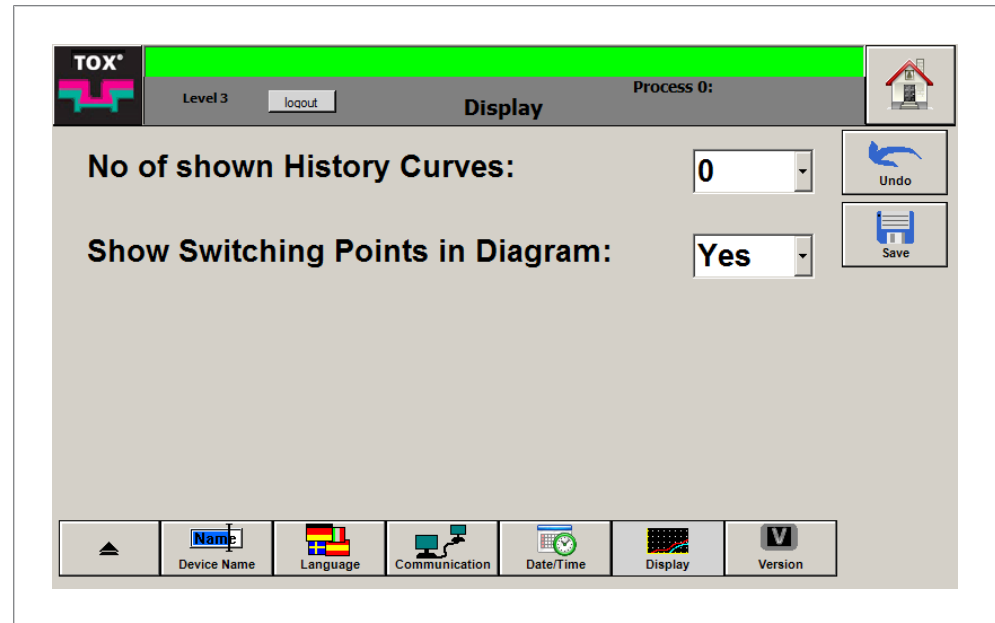

Fig. 64 "System \ Display" menu

- ✓ The user is logged in with a suitable user level. The necessary write permissions are available.
1. Select the number of curves to be displayed by tapping on the selection list.
 2. Select whether switching points should be displayed in the diagram.
 3. Tap on **Save** button to save the values.

Displaying Version

In the "System \ Version" menu, the installed SW versions are displayed.

- Operating system
- Dot Net runtime environment
- Software
- Firmware
- Image Version

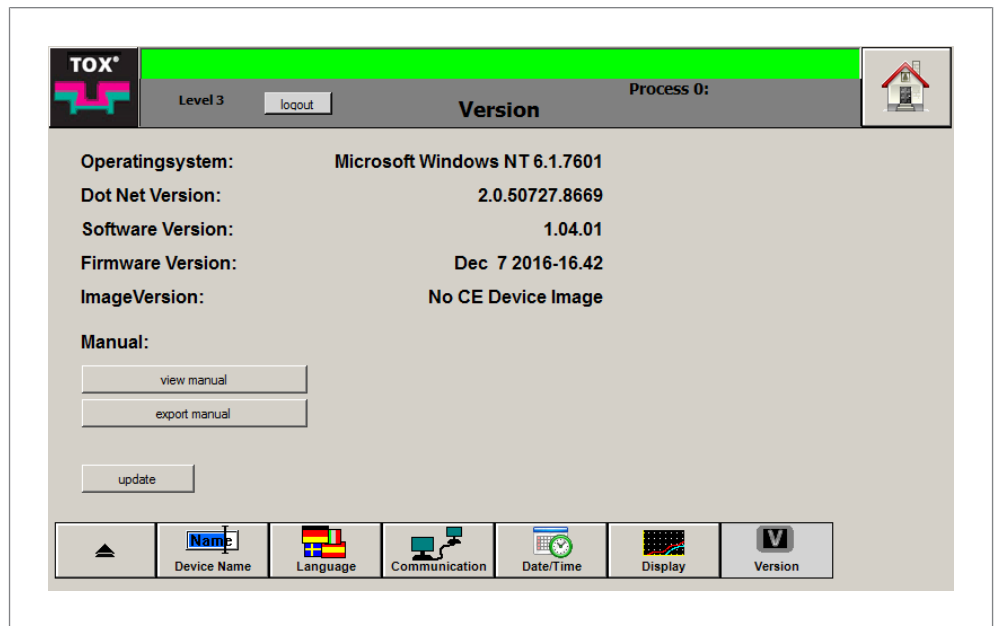

Fig. 65 "System \ Version" menu

Displaying/Exporting Operating Instructions

Displaying Operating Instructions

- ✓ The user is logged in with a suitable user level. The necessary write permissions are available.
- ➔ Tap on **Display operating instructions** button.

Exporting Operating Instructions

- ✓ The user is logged in with a suitable user level. The necessary write permissions are available.
- ✓ External data carrier is connected.
- ➔ Tap on **Export operating instructions** button
- ▶ The operating instructions are saved on an external data carrier.

Updating Software

NOTE

Loss of data by disconnecting the device from the supply voltage!

→ Do not disconnect the device from the supply voltage during the update

- ✓ The user is logged in with a suitable user level. The necessary write permissions are available.
- ✓ The device runs for at least 3 minutes.

1. Unpack ZIP file and copy "EPW500Update" folder to USB stick.
2. Connect USB stick to the device.
3. Tap on **update** button to update the installed software.

Updating Updater

- ✓ The user is logged in with a suitable user level. The necessary write permissions are available.

→ Tap on **update updater** button to update the software installation program.

9.4.9 User

In the "user" menu, the authorizations for the respective menus are configured, e.g. whether buttons or input fields are active. After each startup, the program is at the lowest authorization level.

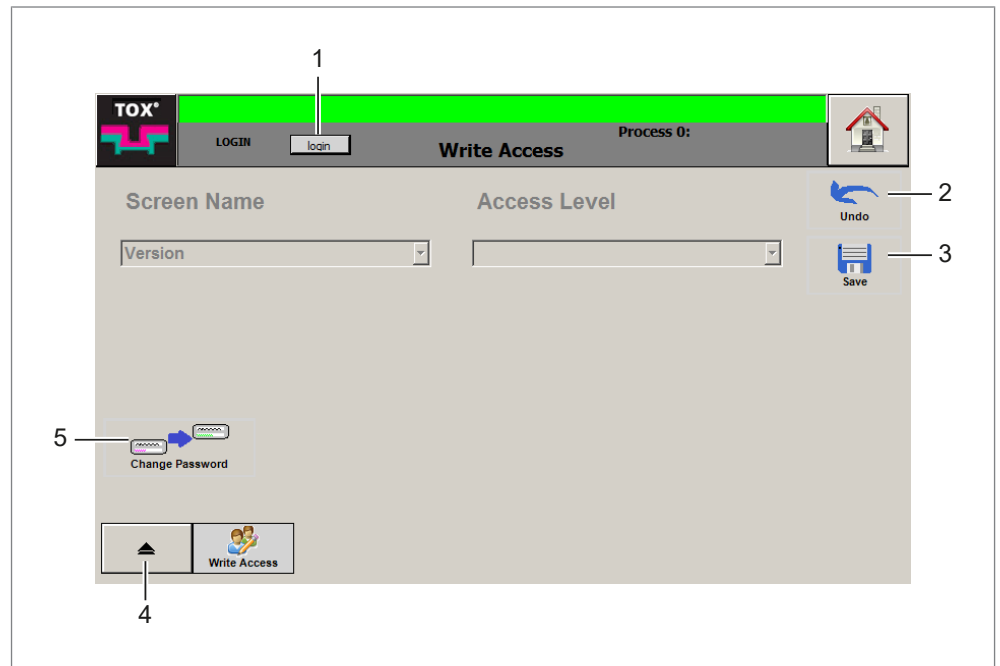

Fig. 66 "user" menu

	Button	Function
1	Login	Login for the authorizations
2	Undo	Undoes the entry
3	Save	Saves the entry
4		Changes to the higher menu
5	Change password	Changes password

Changing User Management/Access Authorization

The pressing monitor has an authorization management system that can limit or enable different operating options and configuration options.

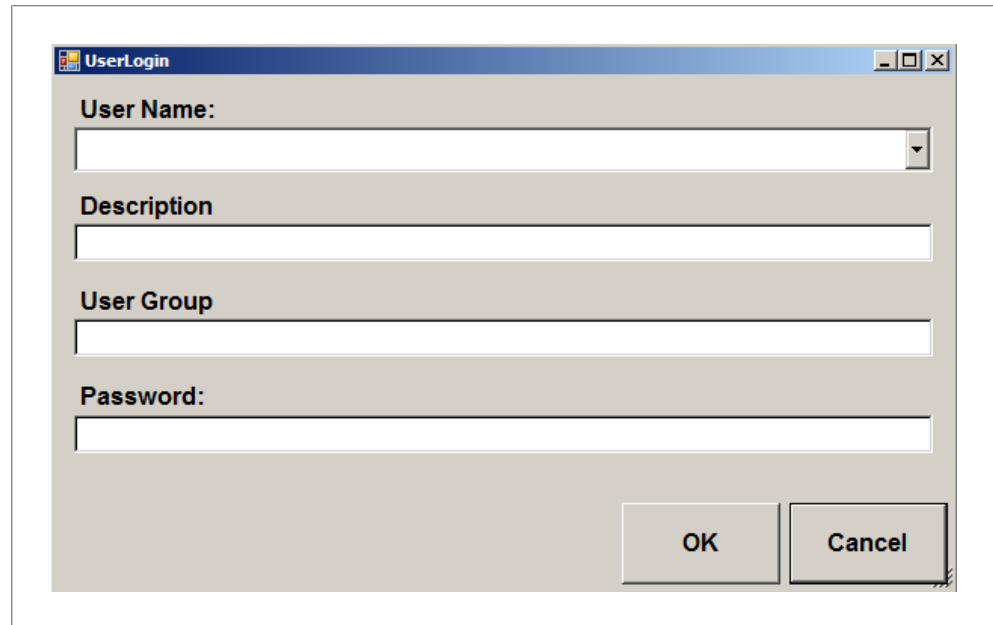

Fig. 67 "User Login" dialog

Authorization	Description	Password
Level 1	Configuration	TOX1
Level 2	Configuration (system, settings)	TOX2
Level 3	Configuration (Service)	TOX3

1. Tap on **login** button.
 - ▷ The "User Login" dialog opens.
2. Tap on **user name** selection field and select authorization level.
 - ▷ The description and user group is displayed in the corresponding fields.
3. Tap on **password** input field.
 - ▷ The alphanumeric keyboard opens.
4. Enter password of the authorization level and press the **OK** button to confirm.
 - ▶ If the password was entered correctly, the selected authorization level is active.
 - OR -
 - If the password was entered incorrectly, a message will appear and the login procedure will be canceled.

9.4.10 Data

Final values

In the "Data \ Final values" menu, the final imported values of a measurement in the internal memory are listed.

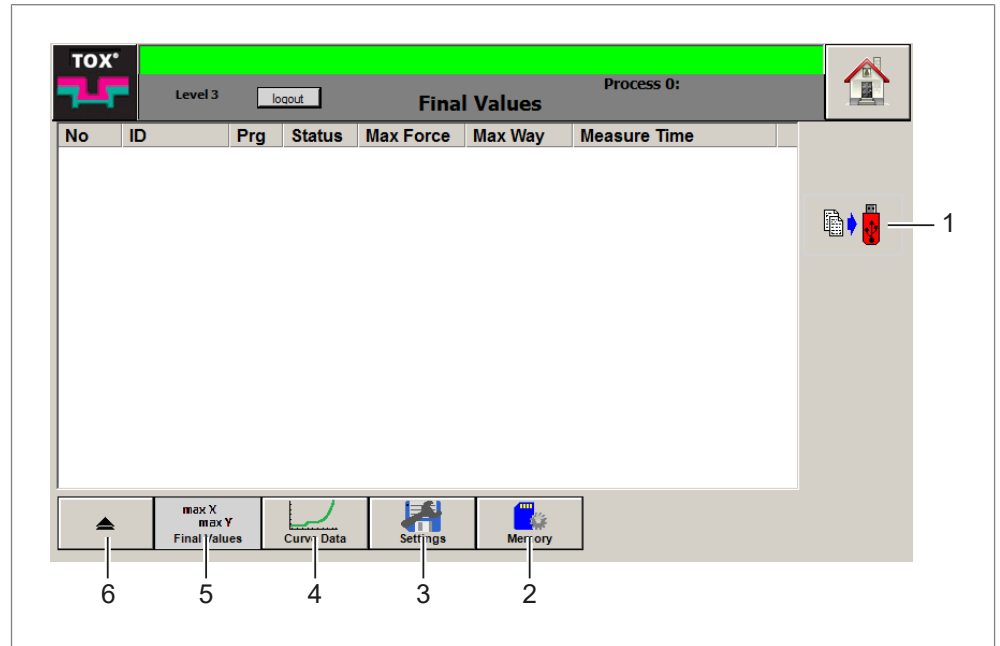

Fig. 68 "Data \ Final values" menu

	Button	Function
1	Save	Saves the recorded data to an external data carrier
2	Memory	Opens Memory menu
3	Settings	Opens Settings menu
4	Curve data	Opens Curve data menu
5	Final values	Opens Final values menu
6		Changes to the higher menu

After each measurement, a final value dataset is saved in the internal memory. This dataset includes the following information:

Parameters	Description
No.	Number of the measurement. 1000 final values are stored in a circular buffer, i.e. with each new measurement, the oldest dataset (= no. 999) is discarded and the newest is added (last measurement = no. 0).
ID	Identification Number Each measurement is indicated with a unique consecutive number.
Prg.	Program used

Parameters	Description
Status	Measurement OK (green)
	Measurement NOK. (red)
Max. force	maximum force
Max. distance	maximum distance
measurement time	Date (dd/mm/yyyy) and time (hh:mm:ss)

- ✓ The user is logged in with a suitable user level. The necessary write permissions are available.
- 1. Connect external data carrier.
- 2. Tap on **Export** button.
- ▶ The data is copied to the connected data carrier.

Curve data

In the "Data \ Curve data" menu, the curve data can be saved. This window contains a list of the value pairs recorded in the internal memory (distance/force) of the last measuring curve.

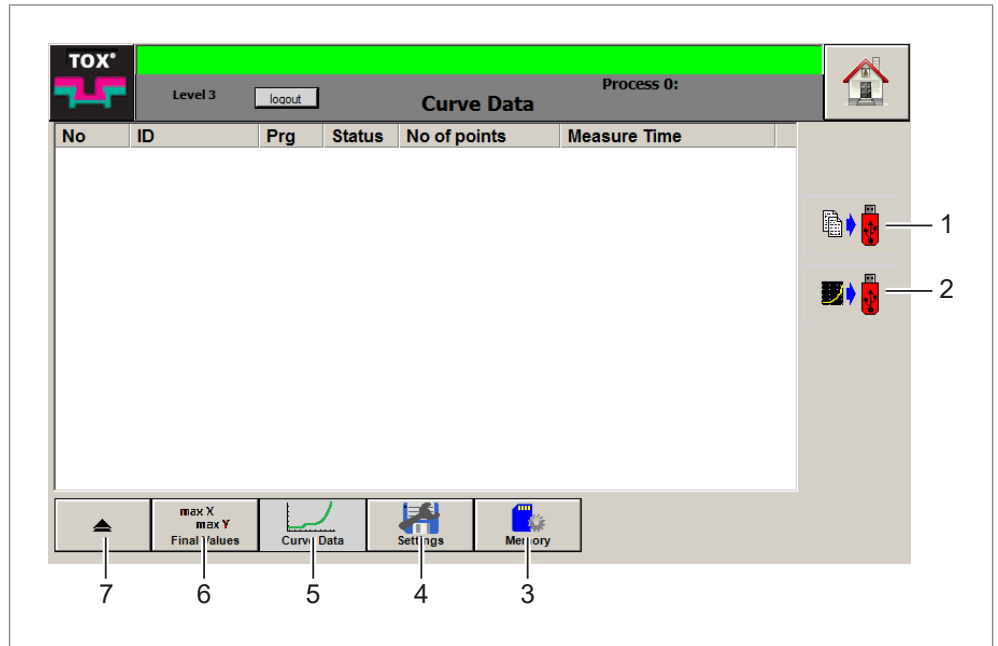

Fig. 69 "Data \ Curve data" menu

	Button	Function
1	Save	Saves the recorded data to an external data carrier
2	Save	Saves the selected curve data to an external data carrier
3	Memory	Opens Memory menu
4	Settings	Opens Settings menu
5	Curve data	Opens Curve data menu
6	Final values	Opens Final values menu
7		Changes to the higher menu

After each measurement, the curve data is saved in the internal memory. This dataset includes the following information:

Parameters	Description
No.	Number of the measurement. 100 curve data are stored in a circular buffer, i.e. with each new measurement, the oldest dataset (= no. 99) is discarded and the newest is added (last measurement = no. 0).
ID	Identification Number Each measurement is indicated with a unique consecutive number.
Prg.	Program used
Status	Measurement OK (green) Measurement NOK. (red)

Parameters	Description
Max. force	maximum force
Max. distance	Maximum distance
Measure Time	Date (dd/mm/yyyy) and time (hh:mm:ss)

- ✓ The user is logged in with a suitable user level. The necessary write permissions are available.
- ✓ In the "Data \ Settings" menu, the storage of the curve data is activated.
- ✓ External data carrier is connected.

- ➔ Tap on **Export** button.
– OR –
tap on **Single Export** button.

- ▶ The recorded curve data is saved on an external data carrier.

Settings

In the "Data \ Settings" menu, you can configure whether data should be saved on an external data carrier or network drive during the export and which data (none, all data, NOK data or OK data).

After the export, the data is available as a CSV file in the corresponding directories.

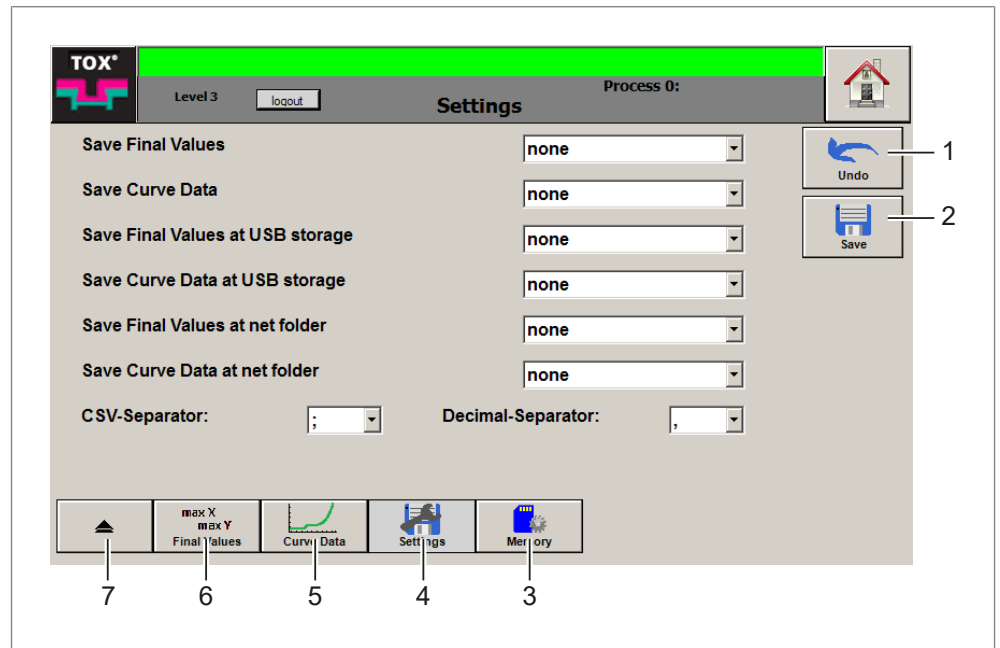

Fig. 70 "Data \ Settings" menu

	Button	Function
1	Undo	Undoes the entry
2	Save	Saves the entry
3	Memory	Opens Memory menu
4	Settings	Opens Settings menu
5	Curve data	Opens Curve data menu
6	Final values	Opens Final values menu
7		Changes to the higher menu

The following values can be selected:

- None
- Only OK
- Only NOK
- all

Selecting Values

- ✓ The user is logged in with a suitable user level. The necessary write permissions are available.
1. Tap on the corresponding selection field and select the desired value.
 2. Tap on **Save** button to save the values.

Selecting CSV Separator

- ✓ The user is logged in with a suitable user level. The necessary write permissions are available.
1. Tap on **CSV separator** selection list and select the desired separator.
 2. Tap on **Save** button to save the values.

Selecting Decimal Separator

- ✓ The user is logged in with a suitable user level. The necessary write permissions are available.
1. Tap on **Decimal separator** selection list and select the desired separator.
 2. Tap on **Save** button to save the values.

Network Drive/USB Stick

All data (final values/curve data) can be retrieved via a network drive or saved to a USB stick.



During high production frequency, the memory expansion should be used as memory location.

The local network and security guidelines must be configured in such a way that communication is not impaired.

Data of the last 10 days are stored in a ring memory in the corresponding folders.

Folder	Memory	Description
EPWCurveExp	Internal	<p>A folder with a corresponding date is created per working day.</p> <p>A folder with corresponding names is created below the day folder for each hour. Each stored curve is filed there as a CSV file with a corresponding date/time.</p> <p>The folder can contain a maximum of 1000 files. If more than 1000 data sets are created, these data sets are written in a new folder.</p>
EPWCurveExt	External	<p>A folder with a corresponding date is created per working day.</p> <p>A folder with corresponding names is created below the day folder for each hour. Each stored curve is filed there as a CSV file with a corresponding date/time.</p> <p>The folder can contain a maximum of 1000 files. If more than 1000 data sets are created, these data sets are written in a new folder.</p>
EPWFinValExp	Internal	<p>A CSV file with a corresponding date is created per working day. All final values together with a corresponding identification are stored in this file</p>
EPWFinValExt	External	<p>A CSV file with a corresponding date is created per working day. All final values together with a corresponding identification are stored in this file</p>
Temp	External	Temporary folder

Network Drive/USB Stick Data Access

If the option **save final values on network drive** or **save curve data on network drive** was selected in the "Data\ Settings" menu, the data can be accessed as follows.

- ✓ The user is logged in with a suitable user level. The necessary write permissions are available.
- ➔ Open Windows[®]-Explorer, enter the IP address of the device and press the **Enter** button to confirm.
- ▶ All corresponding folders will be displayed

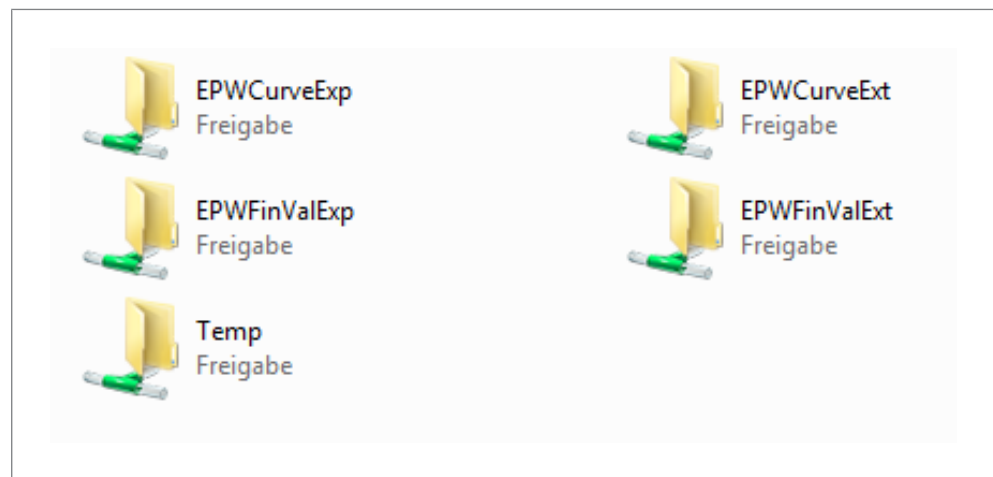

Fig. 71 Network drive folder

Memory

In the "Data \ Memory" menu, an external memory expansion (USB stick) can be initialized and selected.



During high production frequency, the memory expansion should be used as memory location.

See "Data \ [Memory, Page 123](#)" menu

The local network and security guidelines must be configured in such a way that communication is not impaired.

Selecting Memory Location for Usage Data

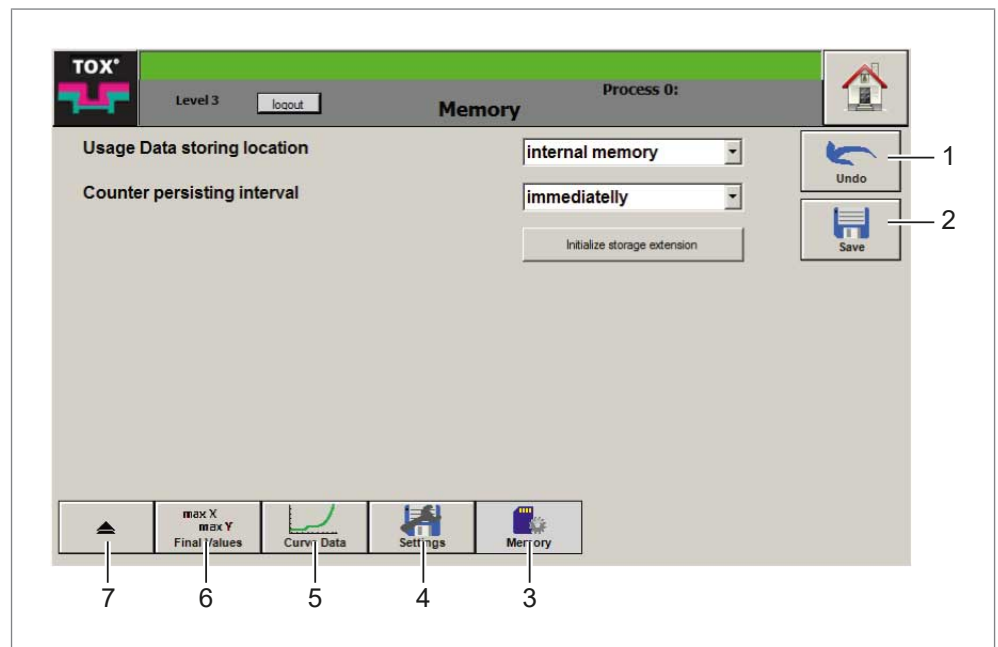

Fig. 72 "Data \Memory" menu

	Button	Function
1	Save	Saves the entry
2	Undo	Undoes the entry
3	Memory	Opens Memory menu
4	Settings	Opens Settings menu
5	Curve data	Opens Curve data menu
6	Final values	Opens Final values menu
7		Changes to the higher menu

- ✓ The user is logged in with a suitable user level. The necessary write permissions are available.
 - ✓ USB stick is inserted.
1. Tap on **Initialize memory expansion** to enable external memory expansion.
 2. Tap on **memory location for usage data** selection list and select "internal memory" or "memory expansion" memory location.
 3. Tap on **storage interval for counter** selection list and select time interval.
 4. Tap on **Save** button to save the values.
- ▶ Memory expansion is activated after restarting.

10 Troubleshooting

10.1 Detecting faults

Faults are displayed as alarms on the pressing monitor. Depending on the type of fault, the alarms are displayed as errors or warnings.

Alarm Type	Display	Meaning
Warning	Text with an orange background in the information and status display of the device.	--
Fault	Text with a red background in the information and status display of the device.	The next measurement is disabled and must be eliminated and acknowledged.

10.1.1 Acknowledging Messages

1. Tap on **error** symbol.
 - ▷ The dialog with all error messages opens.
2. Tap on **Ackn all** button to acknowledge the pending error messages.
- OR -
tap on **Cancel** button to close the dialog without acknowledging the error messages.

10.1.2 Error messages

Fault	Cause	Measure
0001 (HMI RTC time invalid)	Time (panel PC) incorrect	Correct the time (panel PC) in the settings.
0001 (HMI RTC time invalid)	Buffer battery (panel PC) is fully discharged	For spontaneous further operation correct PC time synchronization in Settings. Replace the buffer battery (panel PC)
0002 (Controller RTC time invalid)	Time (hardware) is incorrect	Synchronize time (hardware) with PC time.
0002 (Controller RTC time invalid)	Time (PC) is incorrect	Correct the time of the PC in the settings.
0002 (Controller RTC time invalid)	Buffer battery (hardware) is fully discharged	Buffer battery (replace the hardware).

11 Maintenance

11.1 Maintenance and repair

The recommended time intervals for inspection work and maintenance work must be observed.

The correct and proper repair of the TOX® PRESSOTECHNIK product can only be assured by appropriately trained specialists. The operating company or the personnel in charge of the repair must ensure that the repair personnel are properly trained in the repair of the product.

The repairers themselves are always responsible for the work safety.

11.2 Safety during maintenance

The following applies:

- Observe maintenance intervals if present and stipulated.
- Maintenance intervals may vary from the stipulated maintenance intervals.

The maintenance intervals may have to be verified with the manufacturer if necessary.

- Perform only maintenance work that is described in this manual.
- Inform operating personnel before starting repair work.
- Appoint a supervisor.

11.3 Maintenance schedule

The operating company is responsible for compliance with the maintenance schedules and documentation of maintenance.

1. Ensure that all maintenance work is performed at the intervals specified in the maintenance schedule.
2. Records of completed maintenance work must be kept.



At the end of the chapter is the maintenance table with the maintenance cycles.

11.4 Controller Battery Change

 TOX® PRESSOTECHNIK recommends a battery change after 10 years at the latest.

- ✓ Device is de-energized.
- ✓ Person is electrostatically discharged.
- ✓ Electrically **non** conductive tool for removing the battery.

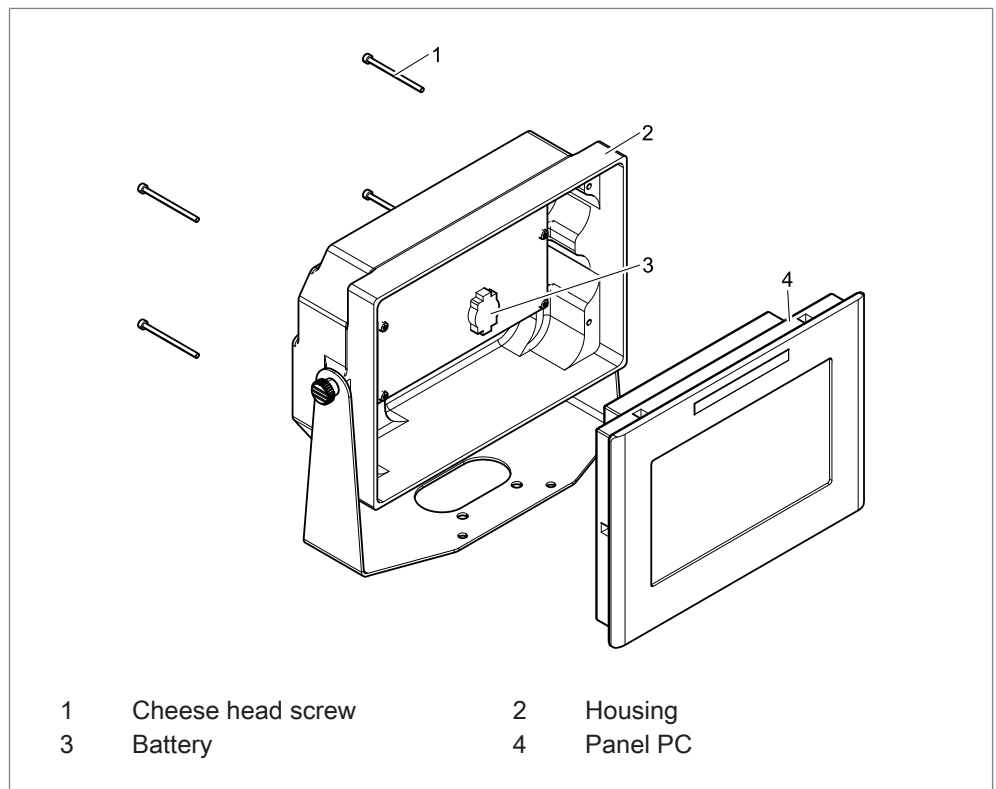

Fig. 73 Opened housing

1. Loosen and remove cheese-head screws.
2. Remove panel PC from the housing.
3. **NOTE!** equipment damage due to short-circuit!
Remove lithium battery using an electrically **non** conductive tool.
4. Install new lithium battery in the correct polarity.
5. Reinsert panel PC into the housing and assemble using the cheese-head screws.

11.5 Panel PC Battery Change



TOX® PRESSOTECHNIK recommends a battery change after 10 years at the latest.

- ✓ Device is de-energized.
- ✓ Person is electrostatically discharged.
- ✓ Electrically **non** conductive tool for removing the battery.
- ✓ A scratch-free base for placing the screen onto.

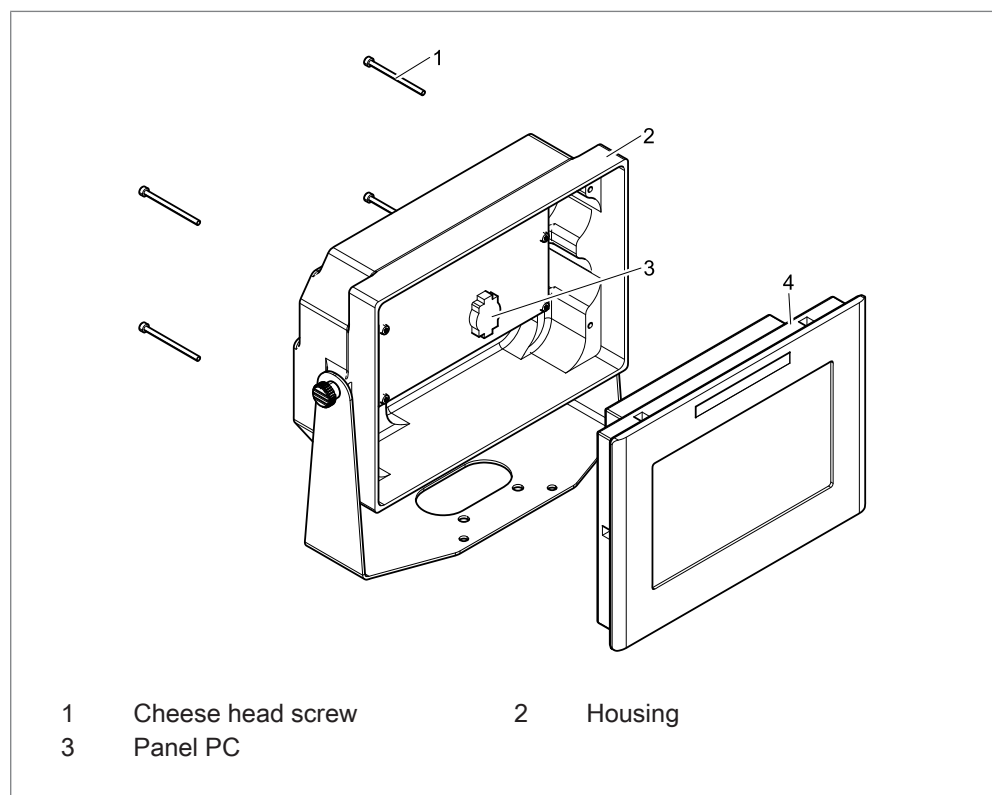

Fig. 74 Opened housing

1. Loosen and remove cheese-head screws.
2. Remove panel PC from the housing and place it onto a scratch-free surface with the screen facing downwards.
3. Remove screws and threaded bolts.

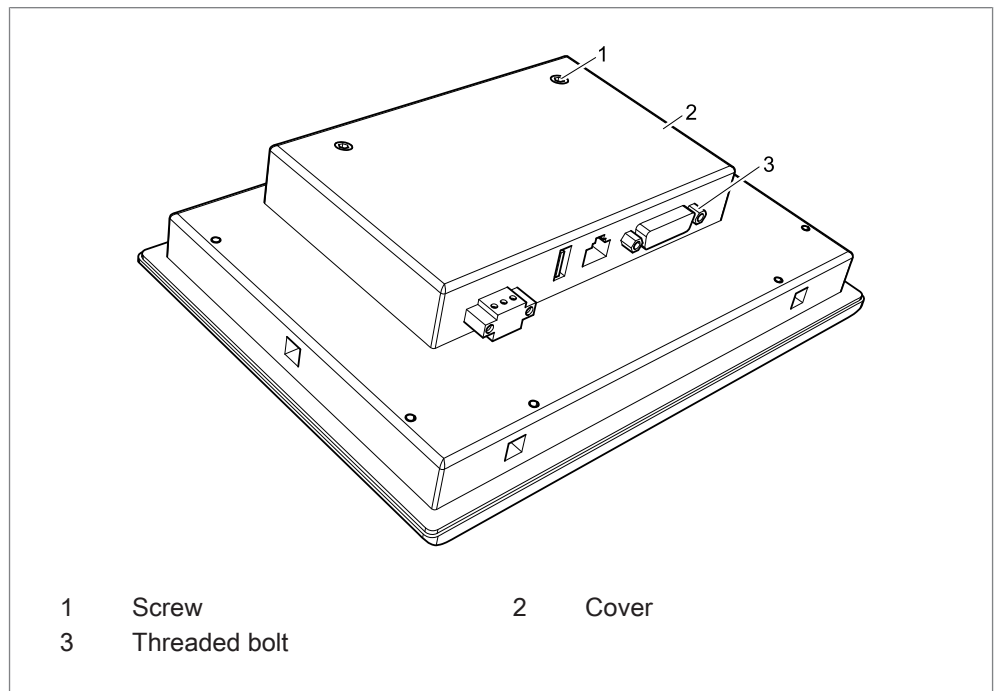

Fig. 75 Open panel PC

4. **NOTE!** Equipment damage due to short-circuit!
Remove cover and lithium battery using an electrically **non** conductive tool.

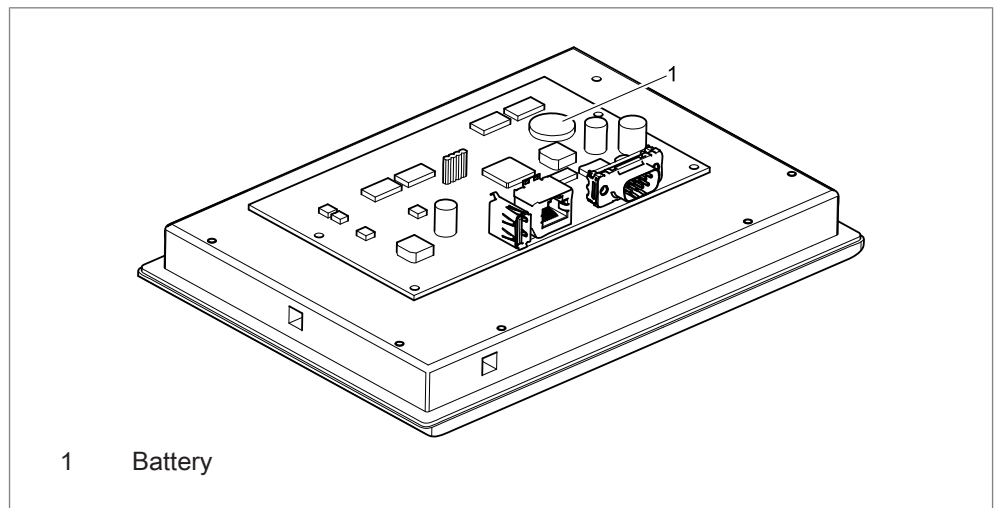

Fig. 76 Replace lithium battery

5. Install new lithium battery in the correct polarity.
6. Install cover and fasten using the screws and threaded bolts.
7. Reinsert panel PC into the housing and assemble using the cheese-head screws.

Maintenance table

The specified intervals are only approximate values. Depending on the area of application, the actual values may differ from the guide values. The actual intervals can be found in the system control.

Maintenance cycle	Additional information	
10 years	11.4	Controller Battery Change
	11.5	Panel PC Battery Change

12 Repairs

12.1 Repair work

No repair work is necessary.

13 Disassembly and Disposal

13.1 Safety requirements for disassembly

→ Have the disassembly carried out by qualified personnel.

13.2 Disassembly

1. Shut down system or component.
2. Disconnect system or component from the supply voltage.
3. Remove all connected sensors, actuators or components.
4. Disassemble system or component.

13.3 Disposal



When disposing of packaging, consumables and spare parts, including the machine and its accessories, the relevant national environmental protection regulations must be complied with.



14 Appendices

14.1 Declaration of conformity

EU DECLARATION OF CONFORMITY

Original EU declaration of conformity

The manufacturer TOX® PRESSOTECHNIK GmbH & Co. KG declares herewith that the following product

Designation/function	Process monitoring
Product name/module	EPW
Model/type	500-FP
Serial number	see type plate
Description	Device for the process monitoring of pressing and joining processes by means of a force/displacement diagram as a compact device for table, wall or support arm assembly

complies with all relevant provisions of the applicable legislation (indicated below), including any changes in force at the moment of the declaration.

The Manufacturer is solely responsible for the issue of this Declaration of Conformity.

Applied EU legislation:

2014/30/EU	EMC Directive
2011/65/EU	RoHS Directive

Applied harmonized standards:

DIN EN 61326-1:2013-07	Electrical equipment for measurement, control and laboratory use - EMC requirements - Part 1: General Requirements
DIN EN 61326-2-1:2013-08	Electrical equipment for measurement, control and laboratory use - EMC requirements - Part 2-1: Particular requirements - Test configurations, operational conditions and performance criteria for sensitive test and measurement equipment for EMC unprotected applications
DIN EN IEC 63000:2019-05	Technical documentation for assessing electric and electronic devices with regard to the limitation of hazardous substances

Place and date	Weingarten, September 21, 2021
Manufacturer	TOX® Pressotechnik GmbH & Co. KG

Signature	
Information on the signatory	Stefan Katzenmaier Component and Region Sales Manager

Index

A

access	
Network drive	122
USB stick	122
access authorization	
Change	114
Adjustment	
Distance sensor offset	55
Force sensor	55
Analog Out	25
authorization	
Change	114

B

Basic safety requirements	13
battery change	
Controller	129
Panel PC.....	130
buttons	
Function buttons	44

C

calibration	
Sensors.....	56
Checkboxes.....	45
Commissioning.....	39
communication	
Configure	108
Define IP address	108
configuration.....	19
Display	110
DMS Characteristic Value.....	58
Input.....	57
Output	57
Sensors.....	53
Switching points.....	73
Contact	11
Control elements	44
controller	
Change battery	129
Counter	
Display in main screen.....	100
Reset counter value	100
Set message.....	99
Set stop.....	100
CPU module	22

D		E	
date		envelop curve	
Set	109	Teach-in	94
Declaration of conformity	139	envelope curve	
description		Delete	95
Function	19	Supplement	95
device name		Switch off	93
Assign	106	Switch on	93
dialog		Environmental conditions	32
Keyboard	46	Error message	126
Save changes	48	Ethernet RJ45	29
Digital	27	Exclusion of liability	7
Input	27	export	
Output	27	CSV separator	120
Digital IN triggered	71	Decimal separator	120
Dimensions	21	Network drive	121
Disassembly	137	Operating instructions	111
Safety	137	Settings	119
Dispatch		USB stick	121
Repair	35	Values	120
display		F	
Configur	110	faults	
Operating instructions	111	Detect	125
Software version	110	force	
Disposal	137	Change	65
distance		Rising	63
Change	65	force sensor	
Rising	59, 63	Adjust offset	55
Rising or falling	61	DMS	23
Distance sensor	25	Standard input	24
Adjust offset	55	Force-triggered	70
Distance-triggered	69	function	
DMS	23	Software	43
DMS Characteristic Value		Function buttons	44
Configure	58	Function description	19
DMS signals	33	G	
Document		Gender note	8
additional	8		
Validity	8		

H

Hazard	
Electrical	16
Hazard potential	16
Holding bracket	
Installation.....	37

I

Icons	49
Identification	
Product	18
Images	
Highlighting	10
Important information	7
Information	
Important.....	7
Information bar	44
input	
Configure	57
Digital	27
Force sensor	24
Input field	45
Installation	37
Holding bracket.....	37
Intended use.....	17
interface	
Software.....	43
USB	28
Interfaces.....	23

J

Job counter	
Display in main screen.....	100
Reset counter value.....	100
Set message	99
Set Stop	100

K

Keyboard	46
----------------	----

L

language	
Change	107
Legal note.....	7
Liability	18
list	
Selection	45
lowercase	
Permanent	46

M		
Main menus	50	
maintenance	127	
Maintenance schedule	128	
Safety	128	
Measures		
Organizational	14	
Measuring mode	19	
Measuring parameters		
Distance rising	59	
Distance rising or falling	61	
Force or distance change	65	
Force or distance rising	63	
Time-triggered	67	
Memory extension	123	
memory location		
For usage data	123	
men		
Data	115	
Menu		
Channel cockpit	50	
Communication	108	
Configuration	53	
Controller	78	
Copy	103	
Counter	96	
Curve data	117	
Date/Time	109	
Digital inputs/outputs	77	
Display	110	
Envelope curve	93	
Filter	79	
Final values	115	
Full-screen display	51	
Hardware	76	
IO Config	57	
Job counter	97	
Language	107	
Measuring parameters	58	
Memory	123	
Monitoring	80	
NOK seq counter	99	
Processes	101	
Save/Load	104	
Sensors	53	
Settings	119	
Shift counter	97	
Start/Stop	68	
Switching points	73	
System	76, 106	
Tool counter	98	
User	113	
Version	110	
Window	84	
Zoom	80	
message		
Acknowledge	125	
Error	126	
Misuse	17	
monitoring		
Operation	41	
Process	19	
N		
NOK options	74	
Nominal Distance		
Set	54	
Nominal Force		
Set	54	
Note		
Gender	8	
General	10	
Legal	7	
Warning signs	9	
O		
operating instructions		
Display	111	
Export	111	
operation	41	
Monitoring	41	
Safe	17	
Organizational measures	14	
output		
Configure	57	
Digital	27	

P

Panel PC
 Change battery 130
 preparation
 System 39
 process 101
 Assign name 102
 Copy parameters 104
 Load parameters 105
 Select 101
 Process monitoring system 19
 Product Identification 18
 pulse diagrams
 PLC interface 30

Q

Qualifications 15

R

Repair
 Dispatch 35
 Repairs 127, 135

S

Safety 13
 Maintenance 128
 safety requirements
 Basic 13
 Operating company 14
 Selection
 Personnel 15
 Selection lists 45
 Selection of personnel 15
 sensor
 Adjust offset 55
 Analog standard signals 32
 Calibrate 56
 Distance sensor 25
 DMS force sensor 23
 Force sensor standard input 24
 Standard signal output 32
 Supply voltage 32
 Sensors
 Configuration 53
 Setting
 Date 109
 Nominal Distance 54
 Nominal Force 54
 Time 109
 Shift counter
 Display in main screen 100
 Reset counter value 100
 Set message 99
 Set Stop 100
 software 43
 Function 43
 Interface 43
 Update 112
 software version
 Display 110
 Source of supply 11
 Special characters 47
 Other 47
 Permanent 47
 Start/Stop
 Digital IN triggered 71
 Distance-triggered 69
 Force-triggered 70
 Time-triggered 72
 starting

System	39
Status bar	44
Status window	52
Storage	35
Temporary storages.....	35
Supply voltage	28
switching points	
Configure	73
system	
Preparing	39
Starting	39
T	
Target group	8
Technical data	21
CPU module	22
Dimensions	21
DMS signals.....	33
Environmental conditions.....	32
Pulse diagrams	30
Sensor	32
Standard signal output sensor	32
Weight.....	21
Texts	
Highlighting	10
time	
Set	109
Time-triggered	67, 72
Transport	35
Troubleshooting.....	125
Type plate.....	18

U

update	
Software.....	112
Updater	112
updater	
Update	112
uppercase.....	47
Permanent	47
usage data	
select memory location	123
USB interface	28
Use	
Intended.....	17
User administration	114

V

Validity	
Document	8

W

Warning signs.....	9
Warranty	18
Weight	21
window	
Activate acute NOK	92
Change condition.....	89
Change size.....	88
Create	85
Delete	91
Move	87
Select.....	86
Status window.....	52

Z

Zoom area	
Change	81, 83