

TOX[®]-Powerpackage Control Units

Data sheet 10.16
2020/05

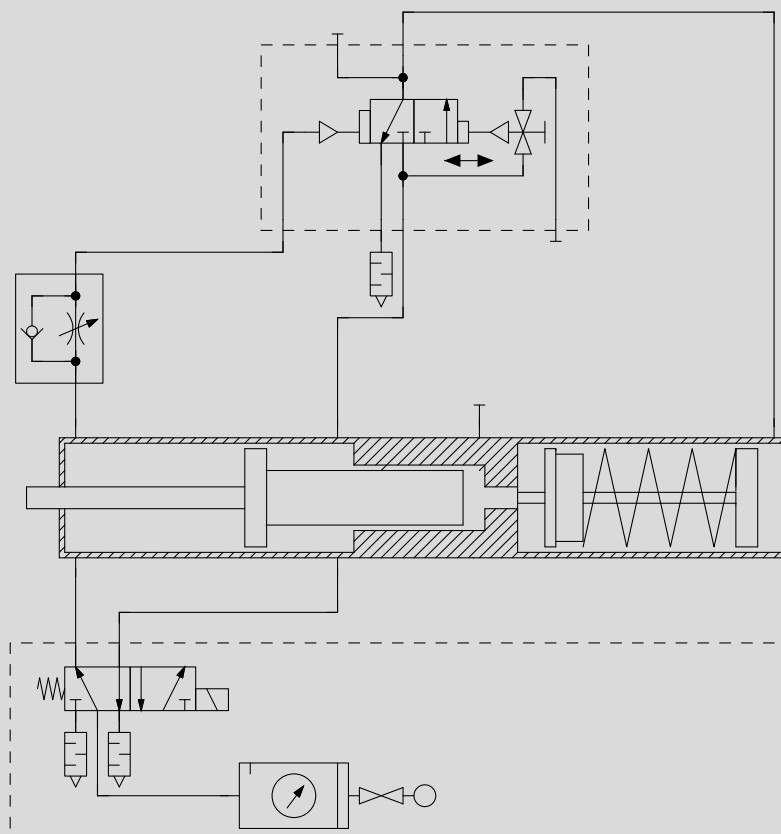

TOX®-Powerpackage Control Units

There are various ways to adapt and optimise the normal stroke of a TOX®-Powerpackage to individual requirements. For this purpose we provide the following control units:

- ZHO: Stroke frequency optimisation
- ZDK: Pressure regulator in the power stroke line
- ZKHZ: External power stroke activation
- Preparation external power stroke activation
- ZKHF: External power stroke release
- ZKHD: Deactivation of the power stroke
- Preparation for external power stroke supply
- Preparation for fast approach stroke support

Control units in detail

Dynamic pressure control

Function: During dynamic pressure control, the automatic switch from fast approach stroke to power stroke occurs every time the working piston meets resistance at any point of the stroke. The power stroke valve is connected to the return stroke chamber via the red control throttle X line and functions according to the dynamic pressure procedure. The changeover time is controlled with the control throttle X.

Application: This control will be supplied by default if no other control was ordered.

TOX®-Powerpackage with mechanical spring

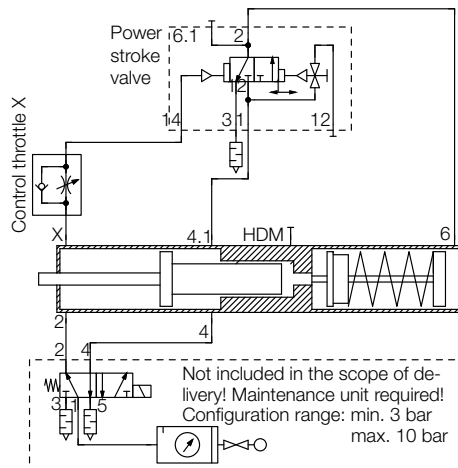

HDM = High pressure measuring connection

TOX®-Powerpackage with pneumatic spring

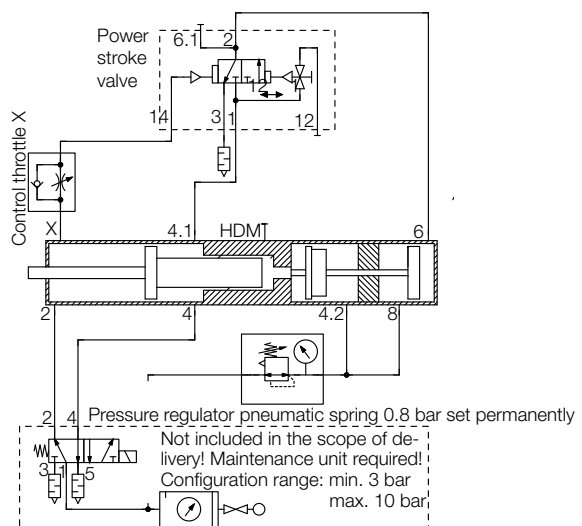

Stroke frequency optimisation ZHO

Function: The ZHO is an optional additional assembly for improving the cycle time. The improvement during the power stroke and power stroke aeration time is approx. 20 %. The ZHO assembly replaces the existing power stroke valve with one of the next size. The control of the power stroke valve is the same as for the standard TOX®-Powerpackage. The control schedule of the dynamic pressure control thus remains unchanged. For the ZHO, an additional fast aeration valve is installed at connection 8 for TOX®-Powerpackages with pneumatic spring.

Application: In particular if the cycle time must be reduced for long power strokes.

Requirement: The ZHO can be attached to TOX®-Powerpackages as well as intensifiers (ES) of TOX®-KT-Systems or upgraded in most cases. In order to optimise the cycle time, a main control valve corresponding to the enlarged power stroke valve with suitable supply line must be available on customer-side. The required size of the supply connection is to be specified.

Compatibility: Compatible with dynamic pressure control, pressure regulator in the power stroke line (ZDK), external power stroke activation (ZKHZ) or external power stroke release (ZKHF).

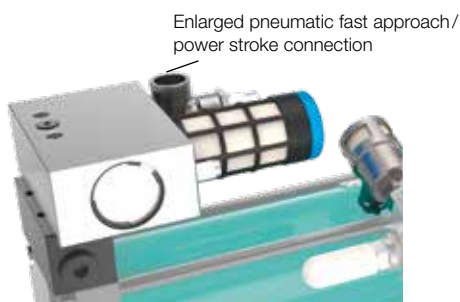

Pressure regulator in the power stroke line ZDK

Function: The ZDK enables individual adaptation of the press force with a manually adjustable pressure regulator, including manometer. The pressure regulator can also be installed further away (e.g. in the switch cabinet). No additional fast aeration valve is required. Alternatively, an electric proportional pressure regulator can be installed in the power stroke line.

Application: For reducing the press force in the power stroke with the same level of fast approach and return stroke force. Attention: Oil pressure min. 60 bar

Requirement: Can be attached to all TOX®-Powerpackages with power stroke valve. The required size depends on the size of the power stroke valve.

Compatibility: Compatible with dynamic pressure control, external power stroke activation (ZKHZ), external power stroke release (ZKHF) and stroke frequency optimisation (ZHO).

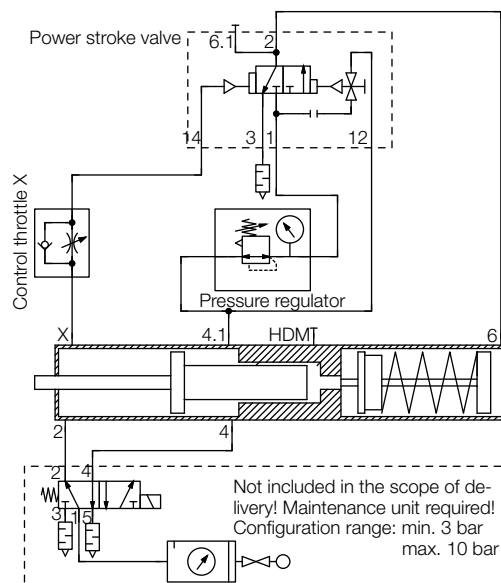

HDM = High pressure measuring connection

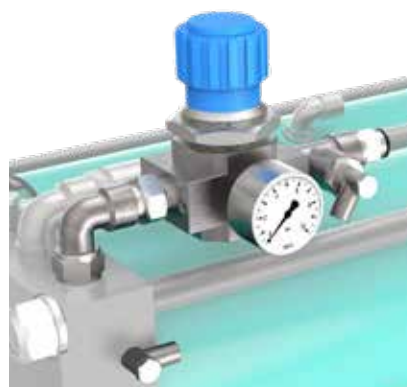

TOX®-Powerpackage Control Units

External power stroke activation ZKHZ

Function: The ZKHZ enables activation of the power stroke valve with an electrically actuated 3/2-way valve.

Application: Recommended for travel-dependent power stroke connection or when using the TOX®-Powerpackage with upwards piston rod and high tool weight. Also usage for application-related interrupted fast approach stroke (e.g. for pressing a spring-loaded holding-down clamp or similar).

Requirement: Can be attached to all TOX®-Powerpackages. A permanent compressed air supply of the electrical 3/2-way valve with 3-10 bar (connection G 1/8") is required. Furthermore, an electrical switching signal (24 V) for activating the power stroke, e.g. a proximity switch ZHS 001 combined with the stroke request ZHU or the output signal of the position encoder ZKW/ZHW.

Compatibility: Compatible with pressure regulator in the power stroke line (ZDK) and/or stroke frequency optimisation (ZHO).

Note: Must only be used for TOX®-Powerpackages with power bypass.

Preparation for external power stroke activation

Function: The TOX®-Powerpackage is prepared for an external power stroke activation on customer-side. The pneumatic filling and venting of the power stroke chamber occur via the normal integrated or external power stroke valve. The pneumatic signal for switching the power stroke valve is made available on customer-side.

An electrical control valve for activating the power stroke is not included in the scope of delivery. The control throttle X connection on the TOX®-Powerpackage is closed by a screw plug, the red control throttle X line is not needed. Input 14 on the power stroke valve remains open for control on customer-side (see control schedule ZKHZ).

Application: If activation of the power stroke is realised by the customer.

Compatibility: Compatible with pressure regulator in power stroke line (ZDK) and stroke frequency optimisation (ZHO).

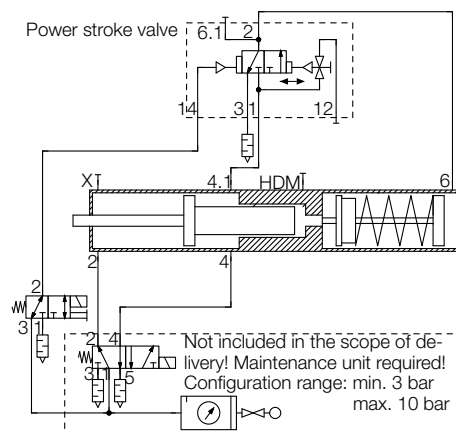

HDM = High pressure measuring connection

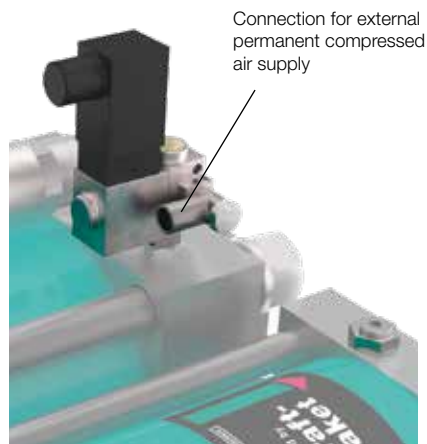

External power stroke release ZKHF

Function: With the ZKHF it is possible to additionally release activation of the power stroke valve by means of dynamic pressure control with an electrical signal.

Application: If the power stroke could be actuated accidentally by the control throttle X due to interference contours in the working area and shall thus be released additionally.

Requirement: Can be attached to all TOX®-Powerpackages. A permanent compressed air supply of the electrical 3/2-way valve with 3 - 10 bar (connection G 1/8") is required. Also an electrical switching signal (24V) for releasing the power stroke.

Compatibility: Compatible with pressure regulator in power stroke line (ZDK) and/or stroke frequency optimisation (ZHO).

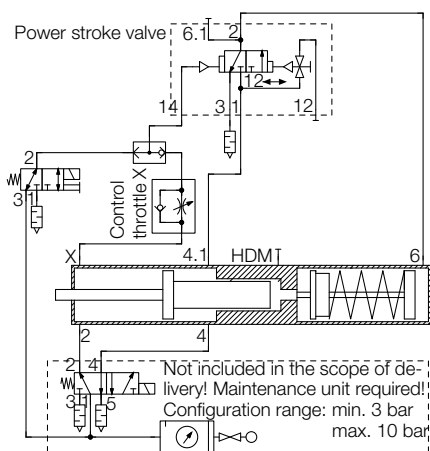

HDM = High pressure measuring connection

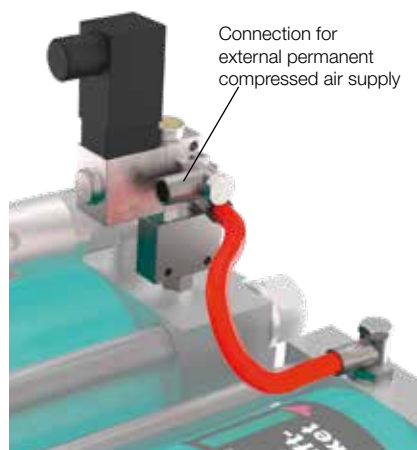

Deactivation of the power stroke ZKHD

Function: With the ZKHD, the power stroke can be deactivated through an electrical signal (e.g. during setup mode). The function is similar to the external power stroke release (ZKHF), but the electrical actuation of the power stroke is disabled.

Application: If a temporary deactivation of the power stroke is required, e.g. in setup mode.

Requirement: Can be attached to all TOX®-Powerpackages. A permanent compressed air supply of the electrical 3/2-way valve with 3 - 10 bar (connection G 1/8") is required. Also an electrical switching signal (24V) for releasing the power stroke.

Compatibility: Compatible with pressure regulator in the power stroke line (ZDK) and/or stroke frequency optimisation (ZHO).

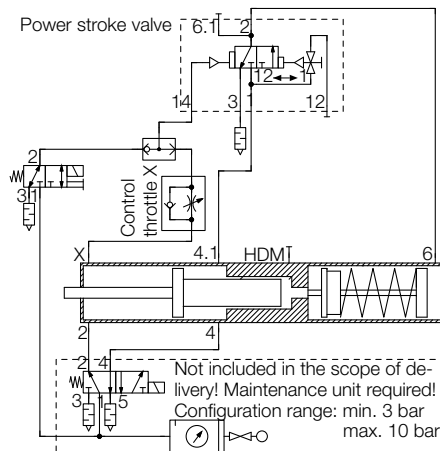

HDM = High pressure measuring connection

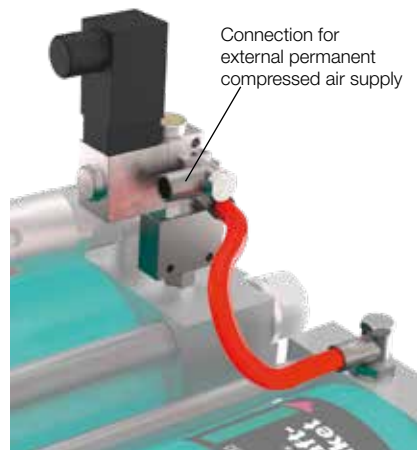

TOX®-Powerpackage Control Units

Preparation for external power stroke supply

Function: The TOX®-Powerpackage is prepared for an external pneumatic supply at the input of the power stroke valve on customer-side. With this type of power stroke supply this can also be permanent pressure unconnected on customer-side. At the TOX®-Powerpackage, connection 4.1 is reduced to thread size G 1/8". Pressure is applied to the power stroke valve via a thin connecting cable. The connecting hole in the power stroke valve is closed with the supplied screw plug.

The power stroke can be activated via a dynamic pressure control or via an external activation or release.

Application: If a separate pneumatic supply of the power stroke valve is desired (independent of the fast approach stroke).

Requirement: TOX®-Powerpackage with TOX® power stroke valve. External pressure supply at connection 1 of the power stroke valve required.

Compatibility: Compatible with dynamic pressure control, external power stroke activation (ZKHZ) or external power stroke release (ZKHF) and stroke frequency optimisation (ZHO).

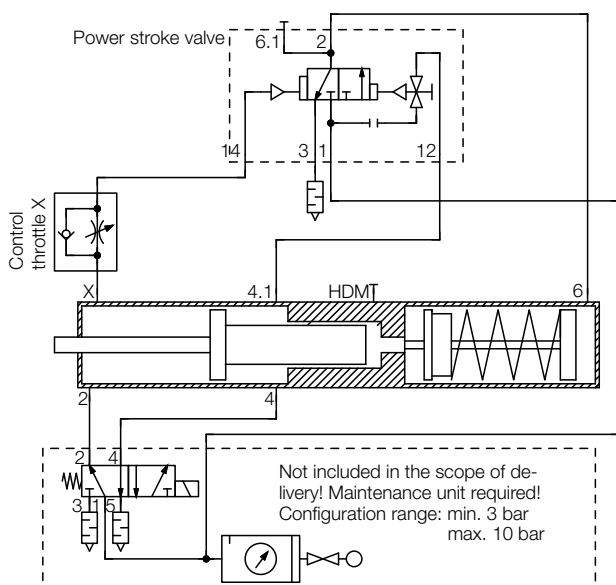

HDM = High pressure measuring connection

Preparation for fast approach stroke support

Function: The TOX®-Powerpackage with pneumatic spring is prepared for fast approach stroke support on customer-side. The pneumatic connection between storage space and plunger return stroke chamber on the TOX®-Powerpackage is closed by a screw plug. Connection 4.2 to the storage chamber stays open for supply on customer-side. The storage piston can thus receive more pressure and support the fast approach stroke. The required control components are not included in the scope of delivery.

Application: When a pneumatic fast approach stroke support is to be realised on customer-side.

Requirement: TOX®-Powerpackage with pneumatic spring.

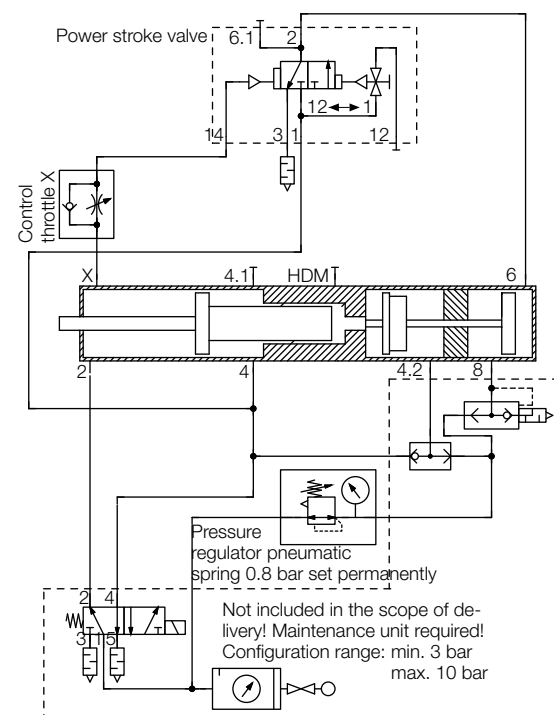

HDM = High pressure measuring connection

Accessories

As world market leader we know which small extras often are of great help.

Helpful accessories (more information in the data sheets 110.00 TOX®-Sensors and 10.10 TOX®-Powerpackage Accessories):

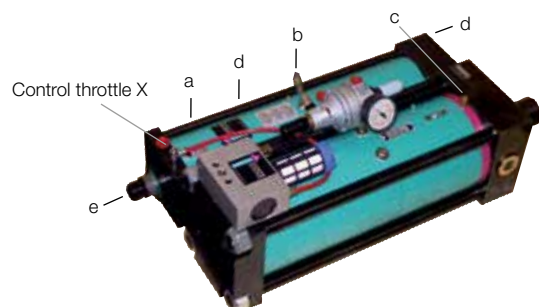

- a. ZHU: Feed and return stroke monitor
- b. ZDO: Electronic pressure switch
- c. ZU 01: Oil level monitor
- d. ZHW/ZKW: Analogue absolute position transducer
- e. ZPS: Press force sensor

Depending on the type of application we recommend:

Punching, piercing



- TOX®-Powerpackage with pneumatic spring
- ZDO: Electronic pressure switch
- FUD: Fixed stop with LDC-damping
- ZSD: Cutting impact damping

Assembling, press-fitting

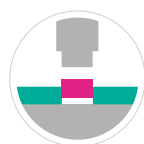

- ZHU: Feed and return stroke monitor
- ZED: Adjustable damping
- ZDO: Electronic pressure switch
- ZHW/ZKW: Analogue absolute position transducer

Clinching, TOX®-Sheet Metal Joining



- ZU 01: Oil level monitor
- GHV: Fixed stop
- ZDO: Electronic pressure switch
- ZPS: Press force sensor